



EKOLOGISKT LANTBRUK NR 37 • MARS 2003

# **EMERGY EVALUATIONS OF DENMARK AND DANISH AGRICULTURE**

**Assessing the Limits of  
Agricultural Systems to Power  
Society**

*Andrew C. Haden*

*Centrum för uthålligt lantbruk*



Ekologiskt lantbruk – 37

Emergy Evaluations of Denmark and Danish Agriculture  
Assessing the Limits of Agricultural Systems to Power Society

Based on the M.Sc. Thesis, by Andrew C. Haden, at the Department of Rural Development Studies (DRDS), Swedish University of Agricultural Sciences (SLU)

Supervisor: Dr. Torbjörn Rydberg, Department of Ecology and Crop Production Science, and the Centre for Sustainable Agriculture (CUL), Swedish University of Agricultural Sciences (SLU).

Centrum för uthålligt lantbruk  
SLU  
Box 7047  
750 07 Uppsala

*Ecological Agriculture – 37*

*Centre for Sustainable Agriculture  
Swedish University of Agricultural Sciences  
S-750 07 Uppsala*

ISSN 1102-6758

ISRN SLU-EKBL-EL--37--SE

ISBN 91-576-6254-1

Antal sidor: 104

Ämnesord / *Key words*: Agriculture; Denmark; Emergy; Empower; Energy analysis; Environmental loading; History; Sustainability; Thermodynamics.



Ekologiskt Lantbruk nr 37 • Mars 2003

# **EMERGY EVALUATIONS OF DENMARK AND DANISH AGRICULTURE**

**Assessing the Limits of  
Agricultural Systems to Power  
Society**

*Andrew C. Haden*

*Centrum för uthålligt lantbruk*





# CONTENT

ABSTRACT .....	3
PREFACE .....	4
1. INTRODUCTION .....	5
1.1 Agriculture, Ecosystems and Society .....	5
1.1.1 Energy Use in Agriculture and Society .....	6
1.1.2 Relating Agricultural and Urban Systems .....	8
1.2 Energy Analysis of Ecological - Economic Systems .....	8
1.2.1 Systems Analysis and Complexity .....	9
1.2.2 Resource Management Science .....	10
1.2.3 Agricultural Science and Emergy Analysis .....	11
1.2.4 Global Emergy Flows .....	11
2. THEORETICAL FRAMEWORK .....	13
2.1 Systems Concepts .....	13
2.1.1 Openness .....	13
2.1.2 Thermodynamic Nonequilibrium .....	14
2.1.3 Self-Organization .....	15
2.1.4 Dissipation .....	16
2.1.5 Growth, Feedback and Autocatalysis .....	16
2.1.6 Nestedness .....	17
2.1.7 Teleological Mechanisms and Ecology .....	18
2.2 Systems Ecology and Emergy .....	18
2.2.1 Origins of the Emergy Concept .....	18
2.2.2 Emergy Theory of Value .....	19
2.2.3 (Em)Power .....	20
2.2.4 Energy Hierarchies .....	20
2.2.5 Energy Quality .....	21
2.2.6 Transformity .....	23
2.2.7 Emergy signatures .....	23
2.2.8 Empower Density and the Energetic Hierarchy of Land-Use .....	24
2.2.9 The Maximum Empower Principle .....	25
2.3 Sustainability .....	26
2.3.1 Sustainability of What and for Whom? .....	26
2.3.2 Availability of Energy Resources .....	26
3. METHODS AND MATERIALS .....	28
3.1 Emergy Evaluation Procedure .....	28
3.1.1 Energy systems diagram .....	28
3.1.2 Emergy evaluation table .....	28
3.1.3 Summary Diagrams .....	29
3.2 Emergy Indices and Ratios .....	30
3.2.1 Sustainability Indices .....	31
4. ANALYSIS AND RESULTS .....	33
4.1 Emergy Evaluations of Denmark .....	33
4.1.1 Description of the System .....	33
4.1.2 Emergy Analysis of Denmark, 1936 .....	38
4.1.3 Emergy Analysis of Denmark, 1970 .....	41

4.1.4	Emergy Analysis of Denmark, 1999 .....	44
4.2	Emergy Evaluations of Danish Agriculture .....	47
4.2.1	Emergy Analysis of Danish Agriculture 1936 .....	48
4.2.2	Emergy Analysis of Danish Agriculture 1970 .....	50
4.2.3	Emergy Analysis of Danish Agriculture 1999 .....	53
4.3	Comparative Indices .....	55
4.3.1	The Danish Economy - Industrialization and Expansion .....	55
4.3.2	Emergy-Based Sustainability Indices of the Danish Economy .....	57
4.3.3	Occupational Diversification - the Emergy Basis for a Service Economy in Denmark.....	60
4.3.4	Danish Agriculture - the Limits of Productivity and Efficiency .....	60
4.3.5	The Transformity of Danish Agricultural Production .....	61
4.3.6	Land Use and Structural Changes .....	62
4.3.7	The Emergy Signature of Danish Agriculture .....	62
4.3.8	Emergy-Based Sustainability Indices of Danish Agriculture .....	64
5.	DISCUSSION AND CONCLUDING REMARKS .....	66
5.1	The Distribution of Structural Complexity in Denmark .....	67
5.2	The Agricultural Treadmill and Reorganization for Maximum Empower .....	67
5.3	Concluding Remarks .....	69
	REFERENCES .....	72
	ACKNOWLEDGEMENTS .....	80
	APPENDIX A - REFERENCES FOR TRANSFORMITIES .....	82
	APPENDIX B - FOOTNOTES TO EMERGY CALCULATIONS .....	83
	APPENDIX C - SYMBOLS OF THE ENERGY SYSTEMS LANGUAGE .....	102

# ABSTRACT

As the process of industrialization has run its course over the twentieth century, the relative importance of agriculture as an economic activity and a means of cultural sustenance for nations has declined dramatically. In this thesis, a historical ecological-economic perspective offers insights into both the causes and effects of Danish agriculture's decline in economic importance relative to the economy of Denmark as a whole. Emergy evaluations were made of the national economy and agricultural subsystem of Denmark for the years 1936, 1970 and 1999. Emergy is defined as all the available energy that was used in the work of making a product and expressed in units of one type of energy (Odum, 1996). In total, six separate emergy analyses were performed. By quantifying the emergy requirements of both a national agricultural system and the economy within which this system is nested, the analysis highlights the changing relationship of these two systems over a temporal scale of 63 years.

The ecological sustainability of the studied systems is assessed through the calculation of emergy-based indices and ratios. In accordance with emergy theory, ecological sustainability is considered to be a function of the dependence of a system on renewable emergy, the degree to which the system depends on imported emergy, and the overall load that the system places on the environment. The analysis indicates that as the national economy of Denmark evolved to rely more on the use of non-renewable emergy and on emergy appropriated through trade to stimulate economic activity and to generate wealth, its sustainability declined, and the importance of the Danish agricultural system to the national economy subsided. While the total amount of emergy supporting the economy of Denmark over the period studied increased substantially, the total emergy supporting agriculture remained relatively constant. Furthermore, though the emergy signature and thermodynamic efficiencies of Danish agricultural production changed significantly, the total emergy required for production fluctuated little. This implies that the thermodynamically optimal level of emergy investment to agricultural production from society may fall within a range that is essentially fixed. Finally, the analysis draws attention to the fact that because agricultural systems are coupled to renewable emergy flows that are limited in the amount of work processes that they can power, agricultural systems register small net emergy yields, thus, agriculture is not likely to be a primary motive force in an economy with access to storages of fossil and other fuels that provide large net emergy yields.

# PREFACE

When I began research for this thesis, my initial objective was to investigate the agriculture-based renewable energy initiatives that are nudging Denmark towards sustainability. The renewable energy infrastructure in Denmark is one of the most highly developed in the world, and has come about largely due to the grass-root efforts of farmers and rural folk. In looking for a way to investigate the topic, I was introduced to the emergy concept. Emergy analysis seemed to be a comprehensive ecological accounting tool that would allow me to objectively assess ecological sustainability, and to uncover the ecological ramifications of rural technology adoption. While emergy evaluations would be a proper tool for such an endeavor, the deeper I delved into the writings of H.T. Odum and colleagues and the emergy literature, the more I learned about the net energy yields of energy sources and their importance as a driving force behind modern societies and their industrial systems. Furthermore, I began to understand the limits of locally available energy sources to meet the current energy demands of modern economies.

Through much study of rural-based renewable energy technologies - such as biodiesel, biogas and wind turbine technology - I began to realize that, while modern renewable energy technologies have undergone considerable development, agriculture is still humanity's most time-tested means of capturing and utilizing solar energy. With my background in ecological agriculture, I chose to focus my efforts on understanding the relationship between Denmark's agricultural system and the economy that it is embedded within. Moreover, I wanted to thoroughly explore the theoretical basis of emergy analysis, as I found it to be an enlightening framework from which to interpret the underlying dynamics of industrialized agricultural systems and to consider the natural resource crises facing the Earth today. Ultimately, my objective with this research was to come to a deeper understanding of the role that resource use plays in shaping the organization of human society, and how this resource use influences the evolution of agricultural systems. As I explored the theoretical ecology and ecological economic literature and then turned my attention toward agriculture and rural systems, I found myself viewing energy and resource consumption and the part they play in the build-up and break-down of societal structures through the lenses of ecological energetics, self-organization and nonequilibrium thermodynamics. By performing an emergy analysis, I was able to make operational many of these intriguing concepts, and the thesis became a quantitative analysis of the influences that different patterns of energy and resource use have on society and agricultural systems, over time.



# 1 INTRODUCTION

This thesis is about the role that energy and natural resource use plays in shaping the organizational structure and ecological sustainability of agricultural systems and society. At the core of the thesis are energy and material flow analyses of Denmark and Danish agriculture at three time intervals: 1936, 1970 and 1999. The analyses highlight the changing relationship of an agricultural system to its surrounding economy over a 63-year time scale, using emergy analysis and the theories that precede it to explain this relationship. Emergy is defined as the available energy of one kind previously used up directly and indirectly to make a service or product, usually quantified in solar energy equivalents (Odum, 1988, 1996). As a quantitative evaluation technique, emergy analysis can be used to assess the natural resource requirements of whole economies as well as individual production processes and ecosystems, based on the amount of solar equivalent energy that they require for their productivity and maintenance (Odum, 1996). The evaluations of Denmark in this thesis provide an overview of the ecological and economic context in which Danish agriculture was and is embedded, and clarify how the resources utilized by a society are a dominant force influencing rural change processes. This introductory section outlines the global context of the thesis, explains the rationale behind applying systems concepts with roots in theoretical ecology to the study of agricultural and economic systems, and highlights the significant role that energy availability and use has played in the progression of human society.

## 1.1 Agriculture, Ecosystems and Society

Agriculture is the primary means through which human societies access ecological systems. However, it is now obvious that the magnitude of the ecological resources appropriated by humans from the planet's natural systems, through agriculture and other means, cannot be maintained at current levels without substantial repercussions (Meadows et al., 1972; Vitousek et al., 1986; Odum & Odum, 2001). The World Resource Institute's recent publication entitled "People and Ecosystems: The Fraying Web of Life" (2000) makes this fact clear, indicating that the health and integrity of the biosphere is increasingly threatened by human activity. During the past two centuries, anthropogenic impacts on ecosystems have become sufficiently severe that many individual ecosystems and even entire ecological regions are exhibiting signs of stress, with many at risk of collapse. While agriculture is humanity's most basic, and arguably its most important, means of biological and cultural sustenance, it is also the primary activity through which we have made our most distinct, lasting and increasingly grave alterations of the planet's terrestrial and aquatic environments (Vitousek, 1997; Jackson, 2002). However, these realizations alone offer no remedy. Because agriculture is so fundamental to human existence, yet has been so detrimental to the ecological systems upon which we all depend,

agriculture deserves increased and continued attention as a key facet of our collective evolution toward a sustainable society.

As concerns about environmental degradation and declining agro-ecosystem health have become increasingly important to global society, the notion that humans need to respect the limits of the biosphere has begun to inform national and supranational environmental policy and research agendas. This idea - that humans are dependent on limited resources and need to adapt actions and policies accordingly - now commonly falls under the rubric of "sustainable development" in both civil society and academic circles (Costanza & Daly, 1992). In academia, the sustainability imperative has spawned a number of new scholarly societies and journals such as *Sustainable Development*, *Ecological Engineering* and *Ecological Economics*. These new fields of study are transdisciplinary in nature and were founded with the purpose of examining in what ways humanity's relationship with the biosphere is out of balance, and seek to find how a balance might be re-established. At the core of these new disciplines is an evolving set of research methodologies, developed to examine and understand complex problems that include an ecological component (Odum, 1996; Holling, 2001; Kay et al., 1999). These new disciplines, and the scholars who contribute to them, are constructing new theories, new patterns of inquiry and new vocabularies that have matured beyond polemics, yet are capable of elucidating the immutable dependence of society on natural ecosystems (Daily, 1997).

### **1.1.1 Energy Use in Agriculture and Society**

Energy availability and use is a critical factor influencing the organization of modern societies and their systems of agriculture. For millennia, the agricultural systems of the world were run on locally available, contemporary energy sources and materials, and fostered the growth of complex, locally-adapted economic, cultural and knowledge systems - albeit in a world with far fewer people than today (Pimentel & Pimentel, 1979; Pimentel, 1989; Odum & Odum, 1976; Odum, 1971). Over the past 100 years, agricultural systems, agricultural technology and the socioeconomic structures to which they are coupled have been transformed dramatically, and nowhere has this transformation been so pointed as in the industrialized and newly industrializing regions of the planet (Björklund et al., 1999; Conforti & Giampietro, 1997; Cochrane, 1993; Odum & Odum, 1976). Furthermore, the industrialization of agriculture has been a source of lament for all those who consider the viability of rural communities and the health of agricultural lands to be key components of a sustainable society (Waltner-Toews. & Wall, 1997; Pretty, 1998).

To understand the role of agriculture in modern industrial society, it must be understood within the context of humanity's long journey in learning how to harness and utilize different forms of energy (Adams,

1988). This history can be broadly conceptualized as a shift from food and wood energy fueling society, to coal and then oil, natural gas, hydroelectricity and nuclear energy as the main driving forces behind economic growth and cultural development (Odum, 1971; Odum & Odum, 1976; Goldemberg, 1997). This development parallels the shift to industrial society from an agrarian base (Mayumi, 1991), and has been referred to as a process of "dis-embedding" of society from its life-support ecosystems (Borgström-Hansson & Wackernagel, 1999).

Early societies, based on hunting and gathering and/or primitive agriculture, developed by harnessing and utilizing natural, locally available energy sources - sun, soil, wind, and rain - in combination with human and animal labor (Odum & Odum, 1976; Pimentel & Pimentel, 1979). The industrial revolution, with its concomitant increase in the use of fuels of increasingly higher quality, expanded the signature of energy gradients that society could harness. These new auxiliary energy sources differed substantially from those previously available in that they were released into the biosphere by human beings and, while their formation occurred through natural processes, their rates of release, the qualities to which they were transformed, and the processes to which they were coupled distinguished their use as a distinctly anthropogenic phenomenon. Figure 1.1 depicts this transformation from hunter/gatherer society to modern urban society using energy systems diagrams [see section 2.2 and Appendix C] and highlights the shift from a reliance on wild ecosystems to the increasing dominance of domesticated crops and the use of fossil fuels and minerals.

This thesis analyzes the transition of Danish society from a state best characterized by diagram (b) in figure 1.1, to an organizational state that more closely resembles diagram (c). While Denmark is the case study for this thesis, a similar trend has been witnessed in most of the industrialized world (Goldemberg, 1997). By taking a long-term, overview perspective of the transitions registered in the resource base supporting a modern industrialized nation, this thesis places each analysis of agriculture within the ecological and economic context of the next larger system within which it is embedded.

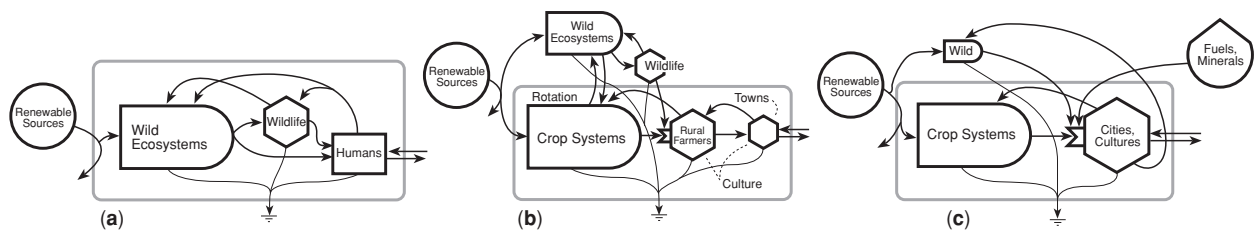

Figure 1.1. Energy systems diagram depicting the energy development in human society through the successive stages of: (a) hunter-gatherer society; (b) agrarian society, (c) and urban society, running mainly on fossil fuels (Redrawn from Odum, 1994a. See appendix C for a description of the energy symbols).

### **1.1.2 Relating Agricultural and Urban Systems**

To understand agricultural systems, it is critical to realize that they are nested within, and co-evolve with, the context of their surrounding societies. In modern societies, agricultural systems are coupled to industrial and commercial systems primarily through trade, and the strength and character of this coupling is increasingly important for agriculture and rural communities. In the context of this thesis, a basic definition of agricultural systems is those systems that reside at the interface of human and ecological systems that sustain human life by channeling flows of food, energy and materials into society. From the standpoint of connectivity and feedback, urban systems generally feed back machinery, information, waste materials and money to agricultural systems in exchange for their produce. From a perspective of energy transformations and the characteristics of living systems - the perspectives that are at the core of the emergy concept and employed throughout this thesis - both agricultural and urban systems are self-organizing, open systems that exist far from thermodynamic equilibrium that must dissipate energy and materials to maintain their order and structure (Nicolis & Prigogine, 1977; Schneider & Kay, 1994; Jørgensen, 1992; Jørgensen et al., 1999). Furthermore, like ecological systems, agricultural and urban systems are reliant upon information for system organization. Generally speaking, in human-organized systems, information takes the form of knowledge and culture and as the processes of urbanization have run their course globally, cultural organization and knowledge has been increasingly concentrated in the urban sector. This trend towards a predominately urban planet is predicated on a large appropriation of resources from both the past production of the biosphere and, from a perspective of intergenerational equity, from the future generations of Earth's inhabitants.

## **1.2 Energy Analysis of Ecological - Economic Systems**

Because there is some energy in everything, it can be used as a metric for the examination of systems of all kinds, from chemical and biological systems to solar systems (Odum, 1971, 1994a; Schneider & Kay, 1994). In comparison to the extensive volume of agricultural science literature that has been produced on individual crop performance, localized plant-soil interactions and specific techniques of animal husbandry, the patterns of energy use and overall organization of national and regional agricultural systems have received less attention from scientists. Similarly, while the measurement of energy dynamics has been common since the inception of the theoretical and applied sciences of physics and engineering, the study of energy and material flow in combined ecological and economic systems is a more recent phenomenon, and is an area of study that tends to be neglected due to its interdisciplinary nature (Odum, 1971, 1987; Odum & Odum, 1976, 2001; Costanza, 1980; Cleveland et al., 1984; Zuchetto & Jansson, 1985; Hall et al., 1986).

The study of the flow of energy in agroecosystems was pioneered by Howard T. Odum and Eugene P. Odum, and emerged from their early studies of the energetics of ecosystems in the 1950's and 60's (Madison, 1997). Since these pioneering studies, the thermodynamic view of ecosystems and economic systems has matured and continues to undergo development (Hall et al., 1986; Schneider & Kay, 1994; Odum, 1996; Jørgensen, 1992; Jørgensen et al., 1999). Increasingly, the aim of thermodynamic approaches to large-scale systems analysis has been to create a synthesis between the flow of energy and materials in both economic and ecological systems, using a common framework (Buenstorf, 2000; Kay et al., 1999; Odum, 1996).

### **1.2.1 Systems Analysis and Complexity**

Agricultural systems are informed by social, economic and ecological dynamics that, when combined, create complexity. Deciphering this complexity in a systematic way presents a formidable challenge. In order to decipher the complexity in an individual part of a given system, it is necessary to have some knowledge of the larger system(s) to which that part is coupled (Odum, 1996). Because most academic disciplines have a window of attention that is focused on one particular temporal or spatial scale, when analyzing systems that are composed of relationships that reach across spatial and temporal scales, it is inevitable that the boundaries of academic discipline will be crossed. However, few realms of science have devised ways of gracefully crossing disciplinary divides. That systems analysis, in its various forms, can handle complexity, and offer researchers a bridge across disciplinary divides is one of its principal strengths, especially as researchers attempt to address environmental problems that do not respect the sometimes arbitrary conceptual boundaries created by academic disciplines. Moreover, calls for transdisciplinary research on natural resource problems stem from the observed tendency of disciplinary science to dissect complex systems into small fragments in order to aid comprehension. This fragmentation often negates the potential of achieving the organic synthesis necessary to shed light on complex problems.

Rigidity in the mechanisms governing formal inquiry has abetted the problem of disciplinary fragmentation, and has encouraged an intellectual estrangement and a lack of coherent discourse between scientific disciplines (Barrett, 2001). This includes disciplines within the agricultural sciences (Röling, 1997). This fragmentation represents a serious limitation for those seeking integrated understanding of complex problems and the limitations of traditional disciplinary science become more evident when the object of study is a complex, open system, such as a whole society. Indeed, the complex, open nature of ecological and societal systems necessitates that the methodologies and theoretical frameworks used to interpret these systems are transdisciplinary, mirroring this openness (Funtowicz & Ravetz, 1994; Ravetz & Funtowicz, 1999). However, transdisciplinary perspectives are new, and

do not often fit neatly into those structures devised during an era when the crises facing global society were less ominous.

### **1.2.2 Resource Management Science**

Emergy analysis, the methodology used in this thesis, holds the potential to function as a platform for an integrative and transdisciplinary resource management science. Although the structures that govern formal inquiry into natural resource management issues have been slow to adopt integrative approaches, new theories that emanate from sub-disciplines of ecology such as emergy analysis and the concept of ecological resilience (Peterson et al., 1998) are beginning to play a role in ecosystem and agroecosystem management (Holling et al., 1998; Kay et al., 1999). In a paper entitled "Energy Systems and the Unification of Science" (1995), H.T. Odum addresses integrated theories for environmental science and management. In the paper he explains how a macroscopic, general systems view is required if environmental science is to generate useful insights regarding systems with driving forces originating from multiple spatial and temporal scales. Furthermore, he conveys the difficulty of adopting a systems view in a scientific culture fixed on isolation of variables at smaller and smaller scales of analysis. With emergy analysis, Odum and his colleagues have evolved well beyond the lip of traditional energy analysis - a tool commonly used to gauge sustainability - and have created a framework for grounding quantitative studies of context specific human-environment interactions in the basic principles governing ecological and general systems (Odum, 1994a).

Since Odum's introduction of general systems principles and energy dynamics to the study of ecological-economic systems in the early 1970's (Odum, 1971; Hall, 1995), there have been many scholars who have adopted similarly macroscopic and integrative perspectives. C.S. Holling (1998), in an article describing two distinct cultures of ecology and science, identifies a basic dichotomy between analytical and integrative schools of thought. The maturation of the integrative stream is evidenced by the fact that, in much of the recent literature addressing the interactions between society and the natural environment, reductionism has been shunned and complexity embraced (Odum, 1987, 1988; Kay & Schneider, 1994; Funtowicz & Ravetz, 1994; Kay et al., 1999; Barkin & Levins, 1997; Tacconi, 1999; Folke et al., 1998; Holling, 2001). Simply put, the complexity of combined social, ecological and economic systems confounds analysis along rigid disciplinary lines. Thus, requisite to inquiry into complex systems are heuristic devices and methodological platforms that allow evaluation of whole systems inclusive of their diverse parts (Odum, 1996; Kay et al. 1999; Holling, 2001). Because emergy evaluation entails a systemic analysis of the relationships of a system's web, through diagrams and the calculation of indices, it allows one to perceive system parts as well as the whole simultaneously. Furthermore, by aggregating resource flows of similar quality, emergy can simplify

complex systems sufficiently to allow their overall energetic context to be perceived and thus more easily understood (Ulgiati & Brown, 1998; Odum, 1995).

### **1.2.3 Agricultural Science and Energy Analysis**

For the better part of this century, traditional agricultural and extension science has been primarily concerned with increasing crop yields and improving the economic efficiency of individual farming systems and farming regions (Röling, 1988). When outcomes are gauged against the relatively narrow palette of performance indicators of gross yield and economic efficiency, agricultural science and extension services have been very successful, and food has become both cheaper and more plentiful in many parts of the world (Conway, 1997). However, the origin and quality of the energy and material inputs used to increase crop yields and economic and labor efficiencies must be carefully considered before the long-term economic performance and ecological sustainability of a given agricultural system can be ascertained. Furthermore, because social and ecological costs are generally not accounted for in economic analyses of agricultural systems, new accounting procedures are needed that consider production efficiency inclusive of its economic, ecological and social context.

Emergy analysis (Odum, 1996) is an environmental assessment tool grounded in the laws of thermodynamics that offers a biophysical alternative to economic analysis. Emergy analyses consider resource use efficiency and yield, dependency on external resources (Ulgiati & Brown, 1998) and the overall load placed on the environment (Ulgiati et al., 1994) by an economy or production process to be the decisive measures of sustainability. Because it allows for multiple dimensions of resource use to be considered on a common basis, it can generate understanding regarding the environmental trade-offs that must be made to increase economic efficiency. Having evolved from ecological energetics, emergy analysis can identify which forms of agriculture are more efficient at capturing and utilizing sunlight energy, versus simply being a conduit for fossil fuels, chemicals and high-tech machinery.

### **1.2.4 Global Energy Flows**

This thesis was written at a time when the Earth was fast becoming an urban planet (FAO, 2002). In order to understand the global context of the analyses offered subsequently, it is important to consider the ramifications of the global urbanization trend from the perspective of emergy. Moreover, coherent explanations for the rural to urban shift at the scale of regions, as well as globally, may be best formulated within the context of the changes in the energy and resource use dynamics that have accompanied this shift. Urbanization is essentially a process through which increased structure is built, and new order maintained, in human engineered environments. Because human economies function as macro-scale dissipative structures, by definition, they require cons-

tant flows of matter and energy to maintain their structure and function (Buenstorf, 2000; Jørgensen et al., 1999). The global urbanization trend is described quantitatively by Brown and Ulgiati (1999) in their presentation of a baseline emergy evaluation of all matter and energy transformations occurring within human and natural systems at the scale of the biosphere. Their analysis indicates that total emergy flows on the planet are now disproportionately based on non-renewable sources. In simple terms, this means that global society is supported by patterns of resource use that are not sustainable in the long term. As Brown and Ulgiati (1999) state in their paper:

"Processes of energy transformation throughout the biosphere build order, degrade energy in the process, and cycle information in a network of hierarchically organized systems of ever-increasing spatial and temporal scales... Society uses environmental energies directly and indirectly from both renewable energy fluxes and from storages of materials and energies that resulted from past biosphere production... Within the last several hundred years, the total inputs of energy released by society to the biosphere, from slowly renewable storages and non-renewable storages, have grown to exceed the renewable ones."

Brown and Ulgiati base their analysis on 1996 data and include the renewable energies to the biosphere such as sunlight, tidal energy, and deep earth heat; renewable materials and energies used directly by society that regenerate more slowly than they are used, such as soils and forests; and non-renewable materials and energies that flow from storages faster than they are regenerated, such as fossil fuels and minerals. From a perspective of the nested-ness of the human economy to the biosphere, their analysis tells us that approximately two-thirds of all processes on earth are self-organizing through the dissipation of non-renewable, human-released energy sources. In other words, human activity is dominating the biosphere. The implications of this are tremendous, especially when we, as a planetary society, are faced with a rapidly increasing human population that will need to be fed and clothed, and enjoy at least some degree of life quality; all things that require time, space and energy, or in a word, emergy.



# **2 THEORETICAL FRAMEWORK**

Ecosystems are our best models of sustainable systems (Jansson & Jansson, 1994; Doherty et al., 2000). If we intend to understand the dynamics of ecologically, economically and socially sustainable agriculture and natural resource management systems, then we must seek to develop theoretical frameworks and research methodologies that aid cognition of the self-organizing dynamics and cross-scale interactions between social systems and ecological systems (Folke et al., 1998; Gunderson, 2000; Holling, 2001). Emergy analysis is an example of a conceptual framework, with a corresponding methodology, that has emerged from ecosystem science and has been coherently adapted to the study of ecologically and economically coupled systems (Odum, 1996; Brown & Ulgiati, 1999). In order to ground the results of the analyses offered in subsequent sections of this thesis in their proper theoretical context, a relatively thorough treatment of the intellectual underpinnings of the emergy concept is presented in the following section. Because they form the basis of the emergy concept, general systems principles and thermodynamic concepts as they relate to human and natural systems are outlined first. The second section deals with systems ecology and emergy analysis; the third section examines the notion of sustainability in light of the theoretical framework.

## **2.1 Systems Concepts**

### **2.1.1 Openness**

Natural ecosystems and human economic systems must be considered open systems because they exchange both matter and energy with their surrounding environments (Jørgensen et al., 1999). While most ecosystems and the biosphere are materially closed or nearly so, there is always some import and export of energy across the boundaries of these systems, necessitating their classification as open systems. Agricultural systems are open in many respects - much more so than natural ecosystems - with natural energies and materials of anthropogenic origin flowing across their boundaries from multiple spatial and temporal scales. In open systems, all ordered structures require a source of useable energy to maintain their order and to build structure. The ingestion of useable energy is predicated on openness and openness is thus considered to be a precondition for structural development and organizational change in any real system (Jørgensen et al., 1999; Brown & Ulgiati, 1999). Without a constant flow of energy and matter across its boundary, a system will degrade away; eventually being drawn towards thermodynamic equilibrium, which can be considered to be the only truly global attractor (Jørgensen et al., 1999; Straskraba et al., 1999).

The export of entropy across a system's boundary is also a precondition of open systems. As agricultural systems import goods and services to maintain their organizational structure and function, they export

entropy - degraded energy not capable of further work - across the boundaries of every component subsystem and across the boundary of the system as a whole. Generally speaking, the creation of entropy can be considered to be a consequence of work (Odum, 1971, 1973, 1996). Because agricultural production requires that work be performed by soil organisms, plants, animals, people, and machines as well as by the larger biosphere processes driven by solar energy such as wind and rain, entropy is a continuous and necessary by-product of all processes underway in agricultural production systems. Furthermore, agricultural systems import concentrated energy in the form of fertilizers, pesticides, feed-stuffs as well as the waste products of societal metabolism (Giampietro & Mayumi, 2000). Beyond gross physical energy, the development of information in the culture and ecological knowledge of humans, which organizes agricultural systems, is a part of the system's structure and function, and also requires work, or the ingestion of useable energy and the exportation of entropy, to be maintained.

### **2.1.2 Thermodynamic Nonequilibrium**

Thermodynamics is the science of the dynamics of heat and the quantitative relationship between heat and other forms of energy. It is the basis for analyzing and studying the transformation of energy from one form to another, the availability of energy to perform work, and the stability and equilibrium associated with chemical substances. The laws of thermodynamics are stated as follows: The First Law states that energy is neither created nor destroyed in circulation and transformation in systems (also called the law of energy conservation). The Second Law, also known as the entropy law, states that available energy is degraded in any energy transformation process. This law implies the irreversibility of processes and has been referred to as "time's arrow" (Straskraba et al., 1999). The Second Law also applies to concentrations and storages of available energy in systems, which are continuously depreciating (Odum, 1996). Entropy, a measure of disorder, refers to energy degraded such that it is no longer able to perform work and is always increasing. The Third Law is rarely discussed in economics or ecology, but is important nonetheless (Jørgensen et al., 1999). The third law states that at temperature 0° Kelvin (-460° F), all entropy stops, and order is at a maximum. Odum (1971, 1996) offers a tentative fourth law of thermodynamics, termed the Maximum Empower Principle (MEP). Odum & Pinkerton (1955) identified this law as "time's speed regulator", or the mechanism regulating the rate at which entropy is generated. The MEP is discussed further in section 2.2.

If there are no gradients of heat or energy in a system that system is said to be at thermodynamic equilibrium. However, all real systems are in some state of thermodynamic nonequilibrium. As stated above, in any system, the import of energy across the system boundary is matched by the export of entropy - degraded energy not capable of further work - across this same boundary. The useable energy in a sys-

tem that can drive work processes is a function of the gradients between a system and its environment. Therefore, measuring the useable energy in a system measures how far a system is from thermodynamic equilibrium with its environment (Kay, 2000). Because ordered structures develop at the interface of differential energy gradients in systems, and are dependent upon those gradients to maintain their structure, non-equilibrium itself can be said to be a source of order (Schneider & Kay, 1994; Günther & Folke, 1993, Nicolis & Prigogine, 1977). Because there are many different storages of useable energy of varying amounts and qualities in agricultural systems, agricultural systems exist in thermodynamic nonequilibrium.

### **2.1.3 Self-Organization**

Self-organization is a process of emergent order at the system level, generated by the non-linear interaction of the system components (Levin, 2000). In turn, macro-level system properties influence the individual components' behavior. The notion of self-organization has its roots in the study of simple chemical systems which exist far from thermodynamic equilibrium (Jantsch, 1980). While some consider self-organization to be the development of system structure and functioning on the basis of local interactions alone (Levin, 1999), others feel that there are system-level selection pressures acting on systems that govern self-organizing processes. The Maximum Empower Principle, after Lotka (1922a,b) and Odum (1971, 1988, 1996) states that systems that self-organize to develop the most useful work with inflowing energy (emergy) sources, by reinforcing productive processes and overcoming limitations through system organization, will prevail in competition with others (Brown & Ulgiati, 1999). This principle is a fundamental theoretical concept underlying emergy analysis and Odum's systems ecology.

The concept of self-organization provides a framework for understanding how systems grow and develop over time that is inclusive of internal constraints and pays attention to thermodynamic limits and their relation to the ability of a system to build and maintain structure, organization and distance from equilibrium (Müller & Nielsen, 2000). It is important to state that while the concept of self-organization stems from the natural sciences, it does not deny human agency (Kay et al., 1999) and can be used to interpret social phenomena. This fact is highlighted by Jantsch (1980) when he states that "a more subtle view of self-organizing dynamics recognizes the degree of freedom available to a system for the self-determination of its own evolution and for finding its temporary optimal stability under given starting conditions". The main characteristic distinguishing between evolutionary feedback mechanisms and self-organization in chemical and biological systems, and in human social and economic systems, is that in human-controlled systems innovations are the result of deliberate decision-making (Buenstorf, 2000).

#### **2.1.4 Dissipation**

Dissipation is defined as the spontaneous (self-organized) change from a more organized and ordered form to a more dispersed and random form (Straskraba et al, 1999). When energy is dissipated, it is "used up" and no longer capable of performing more work, recalling the second energy law. The structure that emerges to dissipate energy, is termed a dissipative structure, and can also be defined as a structure of increasing complexity developed by an open system on the basis of energy exchanges with its environment (Nicolis & Prigogine, 1977). The concept of dissipative structures has emerged from the work of the Nobel laureate physicist Ilya Prigogine (Nicolis & Prigogine, 1977; Jantsch, 1980). Schneider and Kay (1994) have shown that ecosystems can be considered to be (dissipative) structures that dissipate solar energy and in the process build increased levels of system structure and function. This increase results in greater nutrient and energy cycling, more trophic levels and higher overall levels of system organization, information and complexity. Schneider and Kay (1994) use examples from simple chemical systems and scale up to the level of ecosystems and the biosphere. While their conclusions are important, their treatment of dissipative structures tacitly implies, but neatly avoids, teleological explanations.

Emergy analysis, which is based on quantifying the amount of energy dissipated to form a product or to organize a system, includes the above-mentioned concepts and recognizes a type of teleological or governing mechanism. In a paper that addresses the topic of dissipation, Odum (1995) states "The physical chemist who emphasizes random processes that do not have causality tends to say: the faster the dissipation, the more structure generated. Or: Self-organization maximizes rate of entropy generation. The biologist thinking of development of living structure as the means, tends to say: The more structure, the faster the dissipation, the more structure generated.", Odum concurs that both views are correct, but emphasizes that these definitions would be more complete by acknowledging that thermodynamic laws underpin these phenomena. Brown and Ulgiati (1999) address dissipation in their paper and reformulate the concept within a framework of the Maximum Empower Principle (MEP): "Energy dissipation without useful contribution to increasing inflowing emergy is not reinforcing, and thus cannot compete with systems that use inflowing emergy in self-reinforcing ways." (Brown and Ulgiati, 1999). In this thesis, both agricultural systems and the economy to which they are coupled are considered to be macroscopic, self-organized, dissipative structures governed by the MEP.

#### **2.1.5 Growth, Feedback and Autocatalysis**

The growth of a storage in a system is considered autocatalytic when the stored quantity feeds back to increase the overall inflow of energy to the system. The increased energy flow builds more structure which

then, in turn, catalyzes more energy inflow (Odum, 1994a). The stored quantity may be materials, structure or information (Odum, 1988). In general systems theory, this is known as a positive feedback loop. The growth and development of systems takes place through both linear growth and autocatalytic growth. Linear growth prevails when the energy sources available to a system are flow-limited, while autocatalytic growth predominates in systems with access to abundant energy sources (Odum, 1987). If a system is able to utilize some of the energy source available to it to build structures and functions that pull in more energy and result in increased growth, this growth can be autocatalytic and exponential as long as sufficient sources of energy are available to the system. This can be a way of conceptualizing the growth of ecosystems in early stages of succession, as well as the growth of industrialized economies over the past 200 years (Odum, 1994a). In recent history, the world economy grew by dissipating large stores of fossil energy and by investing some of that energy into growing structures (infrastructure, industrial capacity) which effectively drew in more energy, thus catalyzing more growth.

### **2.1.6 Nestedness**

While systems are often depicted as composed of a web of linear relationships, another way of viewing systems is to interpret them as composed of a hierarchy of nested systems; or systems embedded within systems (Günther & Folke, 1993; Capra, 1996; Doherty et al., 2000; Nielsen, 2000). A conception of nested systems was offered by Koestler (1978), who coined the terms "holarchy" and "holon". The word holon means whole/part and describes how various manifest forms are simultaneously whole entities yet are integral parts of the larger systems in which they are nested. A hierarchy of holons is termed a holarchy. This view begins with the hierarchical view of systems and stresses that higher order systems transcend and include their subsystems, and that each system is in some way dependent upon, and responsible to, the systems above and below them. Unlike traditional hierarchical descriptions of systems, the descriptions of systems as forming nested hierarchies are less concerned with top-down control dynamics, thus their interpretation is not based solely on vertically-organized hierarchies (Nielsen, 2000). Günther and Folke (1993) outline the characteristics of living systems in the context of nestedness. Their interpretation hinges on living systems as open systems that exist far from thermodynamic equilibrium, with open communication channels between parts that constrain the organization of living systems. Furthermore, they identify autopoietic (self-maintaining) pathways consisting of autocatalytic feedback loops that work to promote the growth of living systems through the ingestion of useable energy and a commensurate export of entropy. In this thesis, agricultural systems are understood as being nested within their surrounding national economy, which is in turn nested within higher order (global) economies and the biosphere.

### **2.1.7 Teleological Mechanisms and Ecology**

The question of whether ecological systems are teleological is controversial. Teleology is the notion of final causality in systems. The emergy concept is considered by some to be teleological, in that it posits the Maximum Empower Principle (MEP) to be operating as a kind of universal attractor. The MEP is often at odds with the thinking of population biologists and mathematical ecologists who are opposed to the notion of evolutionary mechanisms and selection pressures operating at the level of whole systems (Odum, 1996; Levin, 1999). Descriptions of system behavior as being governed by teleological mechanisms, while often making sense intuitively, are contentious among scholars and considered by some to be unscientific. In an article entitled "On the conceptual foundations of ecological economics: a teleological approach", Faber et al. (1995), use the far-from-equilibrium-self-organizing dissipative structures framework to describe three telos for living systems: 1) the first telos is self-maintenance, development and self-realization 2) the second telos described is replication and renewal, 3) the third telos is that of service to other species and the whole of nature. Odum (1987) has referred to this as "tripartite altruism". It seems rational that the energy and matter dissipated by organisms during their life is dissipated in service of a purpose or cause beyond the dissipation itself. Likewise, it makes sense that a basic principle governing living systems is related to the ability of living systems to invest some of their resources into ensuring that their resource base continues to support them. Furthermore, the idea that systems that reinforce their productive capacity will outlast those systems that do not is altogether sensible. Still, teleological mechanisms are difficult to prove and are something of an intellectual taboo in many scientific disciplines.

## **2.2 Systems Ecology and Emergy**

Systems ecology is defined by Howard T. Odum as "the field that came from the union of systems theory and ecology and provides views on many scales for EMERGY analysis" (Odum, 1996, pp. 289). The theoretical foundations of systems ecology and emergy analysis stem from the observation that both ecological systems and human social and economic systems are energetic systems, that exhibit characteristic designs that reinforce energy use. Moreover, the dynamics of these systems can be measured and compared on an equal basis using energy metrics (Odum et al., 2000; Odum, 1988). Emergy is defined as the available energy of one kind previously used up directly and indirectly to make a service or product, usually quantified in solar energy equivalents (Odum, 1988, 1996). The unit used to express emergy values is the emjoule, and when using solar energy as gauge, the solar emjoule.

### **2.2.1 Origins of the Emergy Concept**

The emergy concept has its origins in the study of the patterns of energy flow that ecosystems develop during self-organization (Odum, 1988).

Formerly known as "embodied energy" (Costanza, 1980), emergy represents a synthesis of systems ecology and energy analysis (Hall, 1995), and has been the main tool used by H.T. Odum and his colleagues to communicate the underlying energy and material flow dynamics exhibited by ecological and economic systems. A number of important publications have documented the history of this concept. The publication of *Environment, Power and Society* (1971) marks the first major publication in which H.T. Odum applies his then recently developed energy systems language and maximum power theories to the combined systems of humans and nature. In 1976, H.T. Odum and E.C. Odum published *The Energy Basis for Man and Nature* which introduced his energy systems concepts to a wider audience by introducing the energy language as a way of depicting energy system design, inclusive of energy and resource quality considerations, and shows how these aspects relate to system growth and development. In 1988, Odum published "Self-Organization, Transformity and Information" in the journal *Science*, which further clarified his concepts of energy hierarchies and system designs, and introduces in concise form, the notions of transformity, emergy and the Maximum (Em)Power Principle. In 1996, Odum published *Environmental Accounting: EMERGY and Environmental Decision Making* which focuses solely on emergy, its conceptual origins and theoretical foundations, and outlines in detail the methodology used to account for resource use in human and natural systems with emergy.

### **2.2.2 Emergy Theory of Value**

The emergy value of a product is not the energy that is left in the product; rather, the emergy value of a product is the amount of energy that has been used up in its creation. It has elsewhere been referred to as the 'memory of energy' that was dissipated in a transformation process (Odum, 1996; Brown & Ulgiati, 1999). Production in ecosystems and economic systems is based on the product of two or more necessary inputs (Odum, 1996, pp. 261). Consequently, if the focus of study is on production derived from systems at the interface of human and natural environments it is crucial to discern what inputs to a production process drive production and what elements are secondary. Likewise, when attempting to account for the contributions of nature to a production or consumption process, the issue of valuation becomes central (Daily, 1997; Rees, 1998; Costanza 2000; Odum & Odum 2000). Like economic cost-benefit analysis, emergy analysis is a valuation process. However, unlike cost-benefit analysis, which considers nature as an externality, emergy analysis is a measure of value of the work of humans and nature on a common basis using energy as measure. Because it assigns value to processes that fall outside the moneyed economy, emergy analysis eliminates many of the problems inherent in monetary valuation (Brown & Herendeen, 1996). In contrast to economic valuation, which assigns value according to utility - or what one gets out of something - and uses willingness-to-pay as its sole measure, emergy offers an oppo-

sing view of value where the more energy, time and materials that are invested in something, the greater is its value (Odum, 1996; Brown & Ulgiati, 1999). The emergy theory of value states that the more previous work done, or energy dissipated, to produce something, the greater is its value. Because work is fundamentally an energy transformation process, in simple terms, with emergy analysis, value is considered to be the result of work (Odum, 1996).

### **2.2.3 (Em)Power**

The sun is the primary energy source powering the work processes of the biosphere, with other significant contributions from the gravitational force of the moon and deep earth heat. All other energy sources must be obtained from storages of the biosphere's previous work. Power is defined as useful energy flow per unit time, and empower is defined as the flow of emergy per unit time (Odum, 1996). As stated in the preceding section, work, in its most simple definition, is an energy transformation process (Odum, 1971, 1996). Because work requires a source of useable energy to be performed, the amount of work that can be done by a system is governed by the amount of power, or energy per time, available to that system. Emergy analysis, which quantifies the previous energy transformations required to create a good or service, is a quantification of the work previously performed to create that good or service. Some systems are able to fuel work processes in excess of their own requirements and are thus considered to have a net yield of emergy. Those storages of previous environmental work, such as hydrocarbon fossil fuels, that are easy to obtain and utilize, generally have a large net yield of emergy, and can therefore power a large number of work processes in addition to the work performed in accessing the emergy storage itself. With regard to agriculture, and other production processes that run partially on contemporary sunlight, it must be noted that there are thermodynamic limits to the ability of these systems to provide (em)power in excess of the emergy invested in the process itself. This is an important fact to bear in mind when attempting to understand the potential of ecological and agroecological systems to power economic processes.

### **2.2.4 Energy Hierarchies**

The observation that "ecosystems, earth systems, astronomical systems and possibly all systems are organized in hierarchies because this design maximizes useful energy processing" (Odum, 1988) is an observation that has helped form the conceptual basis of the systems ecology view of the world. A corollary to this statement is the recognition that in open systems that exist away from thermodynamic equilibrium, energy hierarchies develop as a consequence of self-organization for maximum empower (Odum, 1995). Odum (1971, 1973, 1988, 1994a, 1996, 2000) uses the term energy hierarchy to indicate that in all systems, a greater amount of energy must be dissipated in order to produce a product containing less energy of a higher quality. Observing this pro-



cess of energy transformations in systems of all types indicates that there is a natural order to how energies of differing qualities can be grouped. Figure 2.1 illustrates this concept clearly. Understanding the natural hierarchical order that develops in self-organizing systems may lead to insights about how to manage natural ecosystems and agricultural systems in ways that maximize empower and mutual benefit for humans and nature.

### 2.2.5 Energy Quality

Related to the hierarchical organization of energy in systems is the notion of energy quality (Costanza, 1980; Hall et al., 1986; Odum, 1988). Energy quality refers to the observation that energies of different kinds vary in their ability to do useful work. This principle is often illustrated using the example of coal and electricity, where four joules of coal energy must be transformed to supply one joule of electric power. Because of this necessary transformation, electricity occupies a higher position in

Figure 2.1. Diagram of the energetics of an energy transformation hierarchy. The figure shows the distribution of size and territories of units in each category. (a) Web with energy flows indicated in joules, (b) energy transformation chain formed by aggregating the web by hierarchical position, (c) graph of energy flows at each stage in the energy hierarchy, and (d) solar transformity for each level in the hierarchy (Redrawn from Odum, 1988).

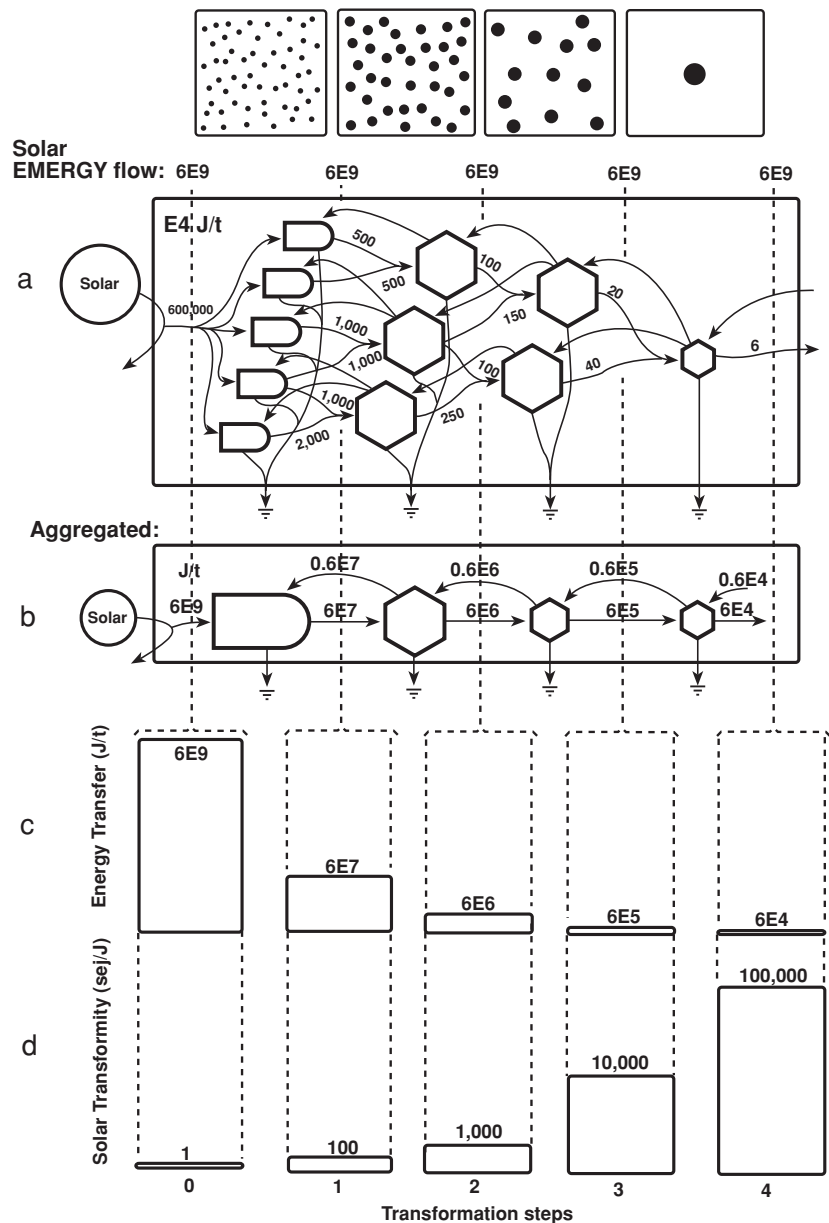

the energy hierarchy than coal and is considered to be of higher quality. The tasks that coal energy and electrical energy are put to indicate how the notion of energy quality translates to the real world. Coal energy is most often transformed into low-grade thermal energy for the purposes of space heating and to create steam to turn turbines for the generation of electricity, while electricity is more versatile, is easily transported, and can power a multitude of engineered, high-technology systems (Odum, 1996).

One distinction that can be made between two prevalent notions of energy quality concerns how the quality of a resource is defined in relation to end users. Hall et al. (1986) define the quality of energy as a function of extraction difficulty, where those energy resources that are relatively easy to extract and process are considered to be of high quality, and resources that are hard to get and process are of lower quality. Odum (1971, 1973), uses a similar notion of energy quality, but later (Odum, 1988, 1996) expands his definition of energy quality to be a

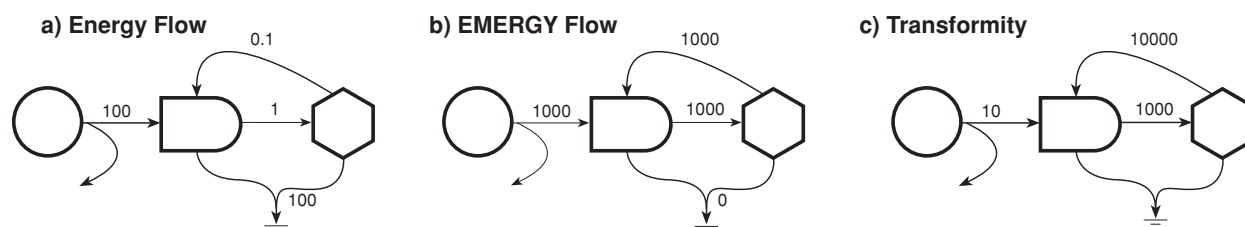

Figure 2.2. Energy flow, emergy flow and transformity through a typical network. The network contains one energy source, a producer, a consumer, a heat sink and the connecting pathways including a feedback reinforcement (adapted from Odum, 1996).

Table 2.1. List of typical solar transformities of various products, resources and information. The sources of the transformities are listed in Appendix A.

Item	Solar transformity (sej/J)	Source for transformity
Sun	1	A
Wind, kinetic energy	1,496	A
Rain, chemical energy	18,199	A
Earth cycle, geological uplift	34,377	A
Coal	40,000	A
Natural gas	48,000	A
Crude oil	54,000	A
Top soil organic matter	74,000	A
Animal feed, concentrates	79,951	F
Electricity	173,681	A
Fisheries production	1,200,000	H
Nitrogen, ammonium fertilizer	1,860,000	A
Phosphate, mined	10,100,000	A
Pesticides	19,700,000	B
Mechanical equipment	75,000,000	D
Genetic information, single tree species	726,000,000,000	A
Genetic information, human DNA	14,700,000,000,000,000	A

function of the amount of previous energy required to make a resource. The basic distinction could be one of retrieval difficulty versus production intensity.

### **2.2.6 Transformity**

When the energy previously used up to make a product is divided by the energy remaining in the product one derives the transformity of that product, expressed as the ratio of solar emjoules per Joule (sej/J). Transformities provide an energy quality factor in that they account for the convergence of biosphere processes required to produce something, expressed in energy units. The more energy transformations there are contributing to a product, the higher is that product's transformity, and that product therefore occupies a correspondingly higher position in the energy hierarchy (Odum, 1996). In this way, transformity can be used as energy scaling ratio to indicate energy quality and hierarchical position (Odum, 1988).

Simultaneously, transformity is an indicator of past environmental contributions that have combined to create a resource, as well as the potential effect on a system that will result from the use of that resource (Brown & Ulgiati, 1997). In contrast to other forms of energy analysis which look only at the flows of heat equivalent energy to a process, emergy analysis - through the use of transformities - is able to depict the effect of system inputs with respect to the time, space and energy needed to form those inputs. This can better articulate the forces driving the self-organizing processes underway in a given system. The accuracy of transformities, and thus emergy analyses, are dependent upon the best and most up-to-date scientific knowledge available. Because the state of scientific knowledge is in perpetual flux, calculations of transformities are open to revision.

There is no single transformity for most products or services. Generally, there is a range of transformities between a lower limit that is necessary to produce something and a theoretically almost-infinite upper limit (Brown & Ulgiati, 1999). A high transformity input may contribute less energy to a process than a low transformity input, but the overall emergy contribution of the two sources may be similar when adjusted for energy quality using transformities. For example, in Danish agriculture as practiced in 1999, coal and sunlight contributed roughly equivalent emergy,  $6.4E+19$  sej and  $6.8E+19$  sej respectively, but the energy contributed by sunlight was 43,000 times greater than coal, measured in joules and without adjusting for quality using transformities.

### **2.2.7 Emergy signatures**

Emergy evaluations involve the quantification of energy and resource flows to and within a system and thus articulate the main forces that are responsible for the organization of the system in question. The

spectrum of energy and resource flows that interact to produce a product can be thought of as representing the "emergy signature" of that production process. Driving forces - which can be thought of as energies that feed and constrain a system - are a key consideration when the focus of attention is agriculture or other environmental production systems. Within an emergy signature, some flows stand out as dominant. These are key flows and represent the energetic limits by which a system is constrained. The emergy signature can be a convenient way of conceptualizing the energy and resource flows around which an ecological-economic system has self-organized. The emergy signature is important when comparing production processes because two processes may have similar total emergy requirements, but have very different requirements in terms of the fractions of renewable to non-renewable emergy required which the emergy signature can help to reveal (Rydberg & Jansen, 2002).

### **2.2.8 Empower Density and the Energetic Hierarchy of Land-Use**

Emergy perspectives on land use often explain the evolution of regional landscape patterns by the change in the density of energy and material use in a given area. The amount of emergy flow in a given space, over a specified time, is termed empower density (Odum, 1996; Brown & Ulgiati, 1997). Because urban areas are characterized by a convergence of emergy flows (Odum, 1996; Odum et al., 2000), urban spaces have a characteristically high empower density (Huang et al., 2001). Because all systems develop energy hierarchies as energy is dissipated and materials are concentrated (Odum, 1988), agricultural and urban systems - which utilize and transform characteristic forms of energy with different levels of concentration - reside at different levels of this energy hierarchy. Specifically, urban systems, which include industrial systems, commercial businesses and high density residential developments, support employment within sectors of the economy that reside higher in the hierarchy of energy transformations than do the economic activities more characteristic of rural areas such as agriculture, fishing, forestry and mining. Figure 2.3 illustrates the basic energetic and hierarchical pattern of land use that characterizes modern societies.

In Figure 2.3, natural ecosystems and agricultural systems are depicted as producer symbols, while residential areas, industrial areas and commercial centers are depicted as consumer symbols [see Appendix C]. This is a simplified diagram showing how natural and human-made ecosystems form the renewable resource basis of modern society by collecting and channeling food, energy and materials into urban society, where they are further transformed into the myriad products upon which modern consumer society is based. In accordance with emergy theory, the arrows that diverge from the center of the diagram indicate how urban systems can exert a controlling influence and partially dictate the organization of agricultural systems by providing information feed-

back, in the form of agricultural land-use and natural resource management policy, as well as simple market demand (Odum, 1971, 1996; Holling & Meefe, 1996)

### 2.2.9 The Maximum Empower Principle

While power is defined as useful energy flow per unit time, empower is defined as energy flow per unit time. Odum postulates that all self-organizing systems evolve in the direction that maximizes empower. The Maximum Empower Principle (MEP) is considered to be the thermodynamic law governing self-organization in all systems (Odum, 1971, 1988, 1994a, 1996; Brown & Ulgiati, 1997, 1999). It is has been called "time's speed regulator" (Odum & Pinkerton, 1955). The principle is controversial (Björklund, 2000; Månsson & Glade, 1993; Cleveland et al. 1997; Adams, 1988) and may ultimately prove to be an untestable hypothesis, but many examples exist in nature and society where the MEP can be seen to operate (Hall, 1995). The MEP has been stated in different ways at different times. Odum has offered the MEP as follows; "In competition among self-organizing processes, network designs that maximize empower will prevail." (Odum, 1996, p. 16). A statement of the MEP that is phrased in a manner more relevant to agriculture is offered by (Brown and Ulgiati, 1999). "Systems that self-organize to develop the most useful work with inflowing energy sources, by reinforcing productive processes and overcoming limitations through system organization, will prevail in competition with others." (p. 488). Alfred Lotka (1922 a, b) originally formulated the basis of the MEP in his consideration of the energetics of natural selection. Buenstorf (2000) offers a thorough treatment of the Lotka principles, saying that "Lotka argued that the direction of evolution could be understood at the system level and suggested that natural selection tends to maximize energy flux through a systems, 'so far is compatible with the constraints to which the system is subject' (1922, p.148)." Odum has offered the MEP as the

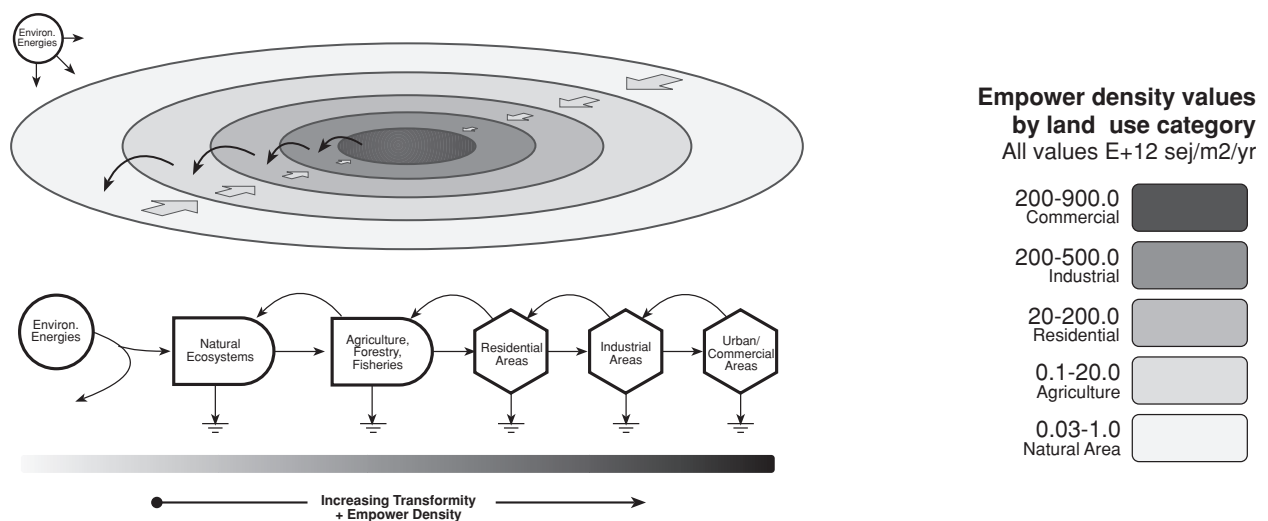

Figure 2.3. Empower density and the energetic hierarchy of land-use. In the diagram, energy and materials converge spatially towards urban centers. In each successive ring, human population density and the energy use per unit area increases (data from Huang et al., 2001; Odum, 1996; Odum et al. 2000).

fourth law of thermodynamics, positing that it is operating on all systems at all spatial and temporal scales simultaneously.

## **2.3 Sustainability**

The concept of sustainability is simultaneously pervasive and elusive. Pervasive in the sense that it is a major force behind a considerable quantity of new research, receives increased investment from society through government agencies and programs and is an overarching theme in many recent international treaties and agreements since the Brundtland Commission Report (WCED, 1987). Yet the concept of sustainability remains elusive because it is difficult to define (Fricker, 1998) and remains still more difficult to implement.

### **2.3.1 Sustainability of What and for Whom?**

Definitions of sustainability must address the fundamental questions of "sustainability of what, for whom" if they are to have relevance. Furthermore, any definition of sustainability must include a time factor. Because this thesis is concerned with the ecological sustainability of agriculture and society it is assumed to be theoretically of concern to everyone. In order to define sustainability in an objective way, a quantitative perspective is appropriate and necessary. However, quantifying sustainability can be a difficult task. The quantification of patterns of (un)sustainability has its roots in the world-system models prepared by Meadows and Forrester for the Club of Rome in the early 1970's. These models began the discussion regarding limits to the growth of the human enterprise, with particular emphasis on population growth, economic growth and the total throughput of materials and energy through human society (Meadows et al., 1972). In addition to energy analysis, a number of tools and methods have emerged that have allowed researchers to quantify resource use and to communicate the effects of that resource use to researchers, decision-makers and laypersons (Doherty & Rydberg, 2002). Because the sometimes disparate topics of energy resource availability and the health of agricultural lands continue to be primary foci of sustainability initiatives, the need for assessment tools that can examine many kinds of resources on an equal basis is critical. This is an area to which energy analysis is well suited.

### **2.3.2 Availability of Energy Resources**

Because economies are open systems that dissipate energy and materials in order to maintain themselves or to grow, their sustainability hinges upon the continued availability of energy and material resources. This may prove to be the ultimate test of the sustainability of economies and production processes. If society develops structures that require large flows of energy from stored quantities of natural resources and fossil fuels, and the storages from which these resources are drawn are depleted, then society must relinquish some of those structures that rely on these natural resources flows or face a forced decline (Odum & Odum, 2001). Thus the sustainability, or lack thereof, of modern so-

ciety is based on transforming, or not transforming, the socioeconomic structures that depend upon non-renewable storages. The sustainable pattern in the long term is a society that runs on contemporary, renewable energy and material flows.

# 3 METHODS AND MATERIALS

Methods for the evaluation of ecological sustainability must aid cognition across the large temporal and spatial scales that are required to accurately assess intergenerational equity (Doherty & Rydberg, 2002). Although tools capable of predicting the multi-faceted environmental consequences of economic decisions have not yet been fully developed, they are emerging (Lewan, 1998), and emergy analysis is one such tool. In this section the methods and materials used to perform the emergy evaluations presented in section 4 are outlined and explained.

## 3.1 Emergy Evaluation Procedure

Odum (1996) gives a detailed explanation of the application of emergy accounting procedures for a variety of systems. What follows is a brief description of the methods used in performing the analyses specific to this thesis. To avoid redundancy, only the procedures for evaluating a national economy are explained, as subsystem analyses entail similar methods and materials.

### 3.1.1 Energy systems diagram

At the core of an emergy evaluation of a given production system or economy is a mass and energy flow analysis in which the flows are adjusted for energy quality using transformities. The boundary for the system studied is defined by the evaluator and it is this boundary that dictates what is considered to be an indigenous resource, an inflow or an outflow for the system of study. An energy systems diagram is drawn using the symbols of the energy language of systems ecology (after Odum, 1971) to graphically represent ecological/energy components, economic sectors and resource users and the circulation of money through the system [see Appendix C for a description of the energy circuit language]. The various components and subsystems are connected with arrows that indicate energy flow as well as causal interactions, material and information flows (Odum, 1996). The boundaries of the systems studied in this thesis are continental Denmark, including Denmark's territorial waters, and the Danish agricultural production subsystem. These systems are evaluated at three time intervals, 1936, 1970 and 1999. As a conceptual aid to the quantitative analyses, non-aggregated overview diagrams were drawn for the Danish economy and Danish agriculture (figures 4.2 and 4.7 respectively). These diagrams graphically depict all major flows and indicate the primary interactions occurring within the system. For simplicity, aggregated diagrams were drawn after all the flows had been quantified. Figure 3.1 is an example of an aggregated diagram indicating the variables used to calculate emergy indices and ratios for a national economy.

### 3.1.2 Emergy evaluation table

After an overview diagram is drawn for the system being evaluated, an emergy evaluation table is prepared using spreadsheet software in which



the primary matter and energy flows passing through the system of study are recorded. All goods are converted to energy units unless the data available was for raw minerals and other materials for which there existed transformities according to mass. Statistics containing data on national imports and exports and agricultural inputs and yields, recorded in biophysical units and in monetary units for calculation of emergy in labour and services, was gathered from Danish national statistical abstracts for both the economy as a whole and for agriculture (Statistics Denmark, 1937; 1968a,b; 1971a,b; 1999a,b,c; 2001). In the calculation tables in Appendix B, the economic category codes for each year were also recorded so that the data can be revisited more easily. Additional data for the agricultural system analyses was gathered from a research paper dealing with the history of energy use in Danish Agriculture (Schroll, 1994). Atlases of Denmark and Danish Agriculture were referred to and provided some of the geographic data needed to calculate environmental inputs to the Danish economy and to agriculture (Royal Danish Geographical Institute, 1986). The emergy table includes the emergy values of the various components in the overview diagram, gathered from the above-mentioned sources. Table 3.1 is a sample emergy evaluation table. Column 1 of the table gives the line number of each item and is a footnote reference for the emergy calculations that are available in Appendix B. The name of the item and the units of raw data for that item - usually joules, grams or dollars - are recorded in Column 2. Column 3 gives the quantity of the component recorded in joules, grams or dollars. The energy, material or currency flow for each item is then multiplied by its respective transformity, which is given in column 4. The product of the raw data and the transformity equals the total emergy contribution of that component to the system. The majority of the transformities used in this study were gathered from previously published analyses (Lagerberg et al., 1999; Odum, 1996; Ulgiati et al., 1994; Doherty et al., 1993; Brown et al., 1993; Brown & Arding, 1991; Odum & Odum, 1983). Column 5 contains letters referring to the study from which each transformity was taken. The studies are listed by their corresponding letter in Appendix A. The total emergy contribution of the component to the system is listed in column 6.

### 3.1.3 Summary Diagrams

When all the flows indicated in the overview diagram have been quantified and tabulated, they are aggregated, and a summary diagram is drawn. All flows indicated in the summary diagrams are in solar emergy joules or US dollars.

Table 3.1. Sample emergy evaluation table.

Note	Item	Data (Units/yr)	Solar transformity (sej/unit)	Reference for transformity	Solar EMERGY (E+18 sej/yr)
1	Sun, J	7.62E+19	1.00	A	76.18
2	Wind, J	3.54E+14	1.50E+03	A	0.53
3	Rain, J	9.81E+16	1.82E+04	A	1785.42

Figure 3.1 is a summary diagram of a national economy showing the variables used to aggregate energy flows. Using nomenclature from Odum (1996) the variables shown in Figure 3.1 refer to the aggregated energy flows supporting a national economy.  $R$  is the sum of the renewable energy flows supporting the economy (i.e. rain, waves, tide);  $N$ , is the sum of nonrenewable resources from within the system (national) boundary;  $N_0$  is the portion of  $N$  from non-concentrated rural sources (mainly soil and forests);  $N_1$  is the portion of  $N$  that is for concentrated use (urban, industrial uses);  $N_2$  is the portion of  $N$  that is exported without use;  $F$  is the sum of all imported fuels and minerals;  $G$  is the sum of imported goods;  $I$  is the total dollars paid for imports;  $P_2 I$  is the emergy in services that accompanies, or is "embodied" in the imported goods and fuels;  $E$  represents the dollars received for exports;  $P_1 E$  is the emergy value of goods and service in exports;  $B$  is the exported products transformed within the system (national) boundary;  $x$  is the Gross Domestic Product of the nation in USD, or other currency;  $P_2$  is world energy/\$ ratio, and is used to value the emergy of services in imports; and  $P_1$  is national energy/\$ ratio in USD, or national currency. These aggregated variables are used to calculate indices that can aid in the interpretation of results of the evaluation.

### 3.2 Energy Indices and Ratios

After tabulating the material and energy flow data for the system in question and correcting for their emergy contributions using transformities, a number of emergy ratios and indices can be calculated. A collection of papers and a book have been published that describe in

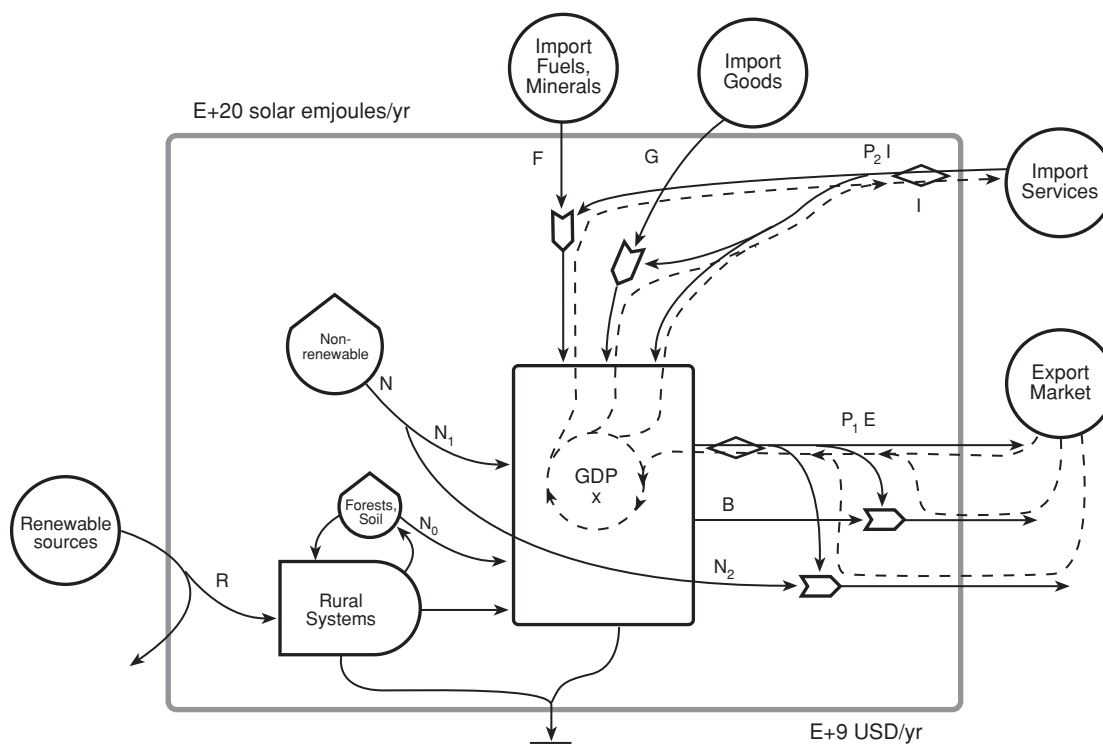

Figure 3.1 Summary diagram of aggregated energy flows for a national economy. The letters next to each flow are the aggregated variables used to calculate emergy indices.

detail various emergy indices, and what they communicate (Brown & Ulgiati, 1997, 1999; Ulgiati & Brown, 1998; Odum, 1996).

The ratios and indices in Table 3.2 provide insight into the organization of national economies and can determine, among other things, the emergy self-sufficiency versus the imported resource dependence of an economy and the degree to which the energy and materials dissipated by an economy are of a renewable or non-renewable character. Moreover, the emergy carrying capacity of a nation and the overall efficiency an economy exhibits in its use of natural resources can be calculated from the results of an emergy analysis. In addition, a number of sustainability indicators based on emergy accounting have been developed recently and allow comparisons of production processes that interface the biosphere at any scale (Brown & Ulgiati, 1997, 1999; Ulgiati & Brown, 1998).

### **3.2.1 Sustainability Indices**

The sustainability of an economy, in emergy terms, is a function of the dependence of that economy on renewable emergy, the degree to which the economy depends on imported emergy, and the overall load that economic activity places on the environment (Brown & Ulgiati, 1997; Ulgiati & Brown, 1998). For smaller scale processes and economic subsystems - such as agriculture - sustainability is considered to be a function of the emergy yielded by the process to the surrounding economy, the degree to which the process relies on renewable emergy flows, and the overall load the process places on the environment (Brown & Ulgiati, 1997). The main indices used to determine the sustainability of an economy or production process are the Emergy Yield Ratio (EYR) and the Environmental Load Ratio (ELR); which, when combined in the Sustainability Index (SI), give a general measure of ecological sustainability. In addition to these, an Emergy Footprint Ratio (EFR) that relates the direct area demand of a system to its indirect area demand is explained and illustrated in section 4.3.2. The following explanation focuses on how sustainability indices are calculated for a national economy.

The Emergy Yield Ratio (EYR) of an economy is expressed as:

$$\text{EYR} = (N_0 + N_1 + R + F + G + P_2 I) / (F + G + P_2 I) \text{ or aggregated as: } U / (F + G + P_2 I)$$

Thus, the quotient that results from dividing the total emergy supporting an economy from all sources, locally available and imported, by the portion that is in the form of imported fuels, mineral, goods and services is a measure of the empower yielded to the national economy and to the higher order (global) economy, from domestic resources. Stated concisely, "the emergy yield ratio of each system output is a measure of its net contribution to the economy beyond its own operation" (Odum, 1996, pp. 71).

The Environmental Load Ratio (ELR) of an economy is expressed as:

$$ELR = (N_0 + N_1 + F + G + P_2 I) / (R)$$

This ratio indicates the quantity of energy inputs to an economy that are not renewable or locally available. The higher the fraction renewable energy used by an economy or production process, the lower the ELR. Conversely, economies and production processes that are highly dependent on outside energy sources have high ELR's. Generally speaking, the ELR indicates the pressure a process places on local ecosystems due to the importation of energy and materials that are not indigenous, and is thus a general measure of ecosystem stress due to economic activity (Ulgati & Brown, 1998).

The Sustainability Index (SI) is expressed as:

$$SI = EYR / ELR$$

The SI assumes that the objective goal of sustainability is to achieve the highest yield ratio attainable while placing the least load possible on the environment. High SI figures indicate that the energy yielded by a production process or economy is to a high degree reliant on renewable energy flows and therefore more compatible with the local environment. A low SI value indicates the opposite.

Table 3.2. Indices and ratios calculated to interpret the results of an energy evaluation.

Name of Index	Expression
Renewable energy flow	R
Flow from indigenous nonrenewable reserves	N
Flow of imported energy	F+G+P <sub>2</sub> I
Total energy inflows	R+N+F+G+P <sub>2</sub> I
Total energy used, U	N <sub>0</sub> +N <sub>1</sub> +R+F+G+P <sub>2</sub> I
Total exported energy	P <sub>1</sub> E+N <sub>2</sub> +B
Fraction energy use derived from home sources	(N <sub>0</sub> +N <sub>1</sub> +R)/U
Imports minus exports	(F+G+P <sub>2</sub> I)-(N <sub>2</sub> +B+P <sub>1</sub> E)
Export to Imports	(N <sub>2</sub> +B+P <sub>1</sub> E)/(F+G+P <sub>2</sub> I)
Fraction used, locally renewable	R/U
Fraction of use purchased	(F+G+P <sub>2</sub> I)/U
Fraction imported service	P <sub>2</sub> I/U
Fraction of use that is free	(R+N <sub>0</sub> )/U
Empower density	U/(area)
Use per person	U/population
Renewable carrying capacity at present living standard	(R/U)(population)
Ratio of use to GDP, energy/dollar ratio	P <sub>1</sub> =U/GNP
Fuel use per person	Fuel/population
Environmental Load Ratio (ELR)	(F+G+P <sub>2</sub> I+N <sub>1</sub> )/(R+N <sub>0</sub> )
Energy Yield Ratio (EYR)	U/(F+G+P <sub>2</sub> I)
Sustainability Index (SI)	EYR/ELR
Energy Investment Ratio (EIR)	F/(R+N)

# 4 ANALYSIS AND RESULTS

## 4.1 Energy Evaluations of Denmark

The energy flows supporting the Danish economy were evaluated for the years 1936, 1970 and 1999. The evaluations were performed in order to gain a detailed, comparative view of the changes in the resource flows of the economy of Denmark over time. The analyses provide the data needed to make substantive comparisons of how changes in the total energy flows at the scale of the national economy have influenced structural changes in the agricultural subsystem of Denmark, which is subsequently evaluated for the same years. Figure 4.1 is a political map of Denmark and Figure 4.2 is an energy systems overview diagram of the main resource flows supporting the combined systems of ecology and economy in Denmark. The purpose of the diagram in Figure 4.2 is to show the internal interactions of the Danish economy for all years. The actual quantities have been omitted from the diagram for simplicity. Diagrams with quantified energy flows are shown in aggregated form for each year evaluated in figures 4.3, 4.4 and 4.5 respectively.

### 4.1.1 Description of the System

With a land area covering 43,070 km<sup>2</sup>, Denmark is a small nation by world standards. Denmark is located in Northern Europe and is the southernmost of the Scandinavian countries. Land use is dominated by cultivated land, with up to 61-65% of total land used for agriculture over the years evaluated. Land use in 1999 was composed of approximately 61% cultivated land, 21% built up or otherwise developed lands, 12% forest and woodland, and 6% meadows and pastures (Statistics Denmark, 1999a). Denmark has a wide variety of soil types ranging from morainic clays, loams and sands, meltwater sands, fluvio-glacial clays, and marine deposits, with the most important physiographic features being products of the Quarternary Ice Age (Kampp, 1969). The highly sculpted coastline of Denmark is approximately 3,379 km long (WRI, 1994) and sand dunes predominate along the entire length of the west coast. With regard to freshwater resources, Denmark is dotted with a number of lakes and streams, yet has no major rivers. Precipitation averages approximately 600-800 mm /yr.

Denmark borders Germany to the south and is surrounded on all sides by sea with the North Sea to the west and the Baltic Sea to the east. The climate is temperate, often overcast, with windy winters and cool summers. The terrain is low, mostly flat, with gently rolling hills and a mean elevation of approximately 30 meters. A map of Denmark is presented in Figure 4.1 showing the main roads, political boundaries, cities and large towns.

In 1999, Denmark had a population of approximately 5,313,000 people. The language spoken is Danish, a language that belongs to the Scandinavian language group. In 1999, approximately half the total popula-

tion was employed and was employed by occupation in the following broad categories; 37% private services, 30% government services, 20% manufacturing and mining, 6.3% construction, 5.6% agriculture, forestry and fishing, and 0.6% in utilities (Statistics Denmark, 2001). The economy is modern, highly dependent on foreign trade and is able to provide high standards of living to all of its citizens. The Gross Domestic Product in 1999 was 1,229,585,000,000 Danish Kronor, or 175,655,000,000 USD, at an exchange rate of 7 DKK per USD. In 1999, electronic equipment manufacturing, international shipping lines, high technology and engineering services, modern wind turbines for the production of electricity, furniture manufacturing, and livestock products were economically important items exported from Denmark.

Politically, Denmark is a constitutional monarchy. While Greenland and the Faeroe Islands are a part of the Kingdom of Denmark, they are self-governing administrative divisions and are not included in this study. Denmark is part of the European Union as well as NATO and maintains a small national army composed primarily of reservists. Agriculture has historically been the mainstay of the Danish economy and is still important today. Because agricultural statistics and energy and resource use statistics are highlighted in the energy analyses that follow, they will not be dealt with here.



Figure 4.1. Political map of Denmark (from Statistics Denmark, 1999).

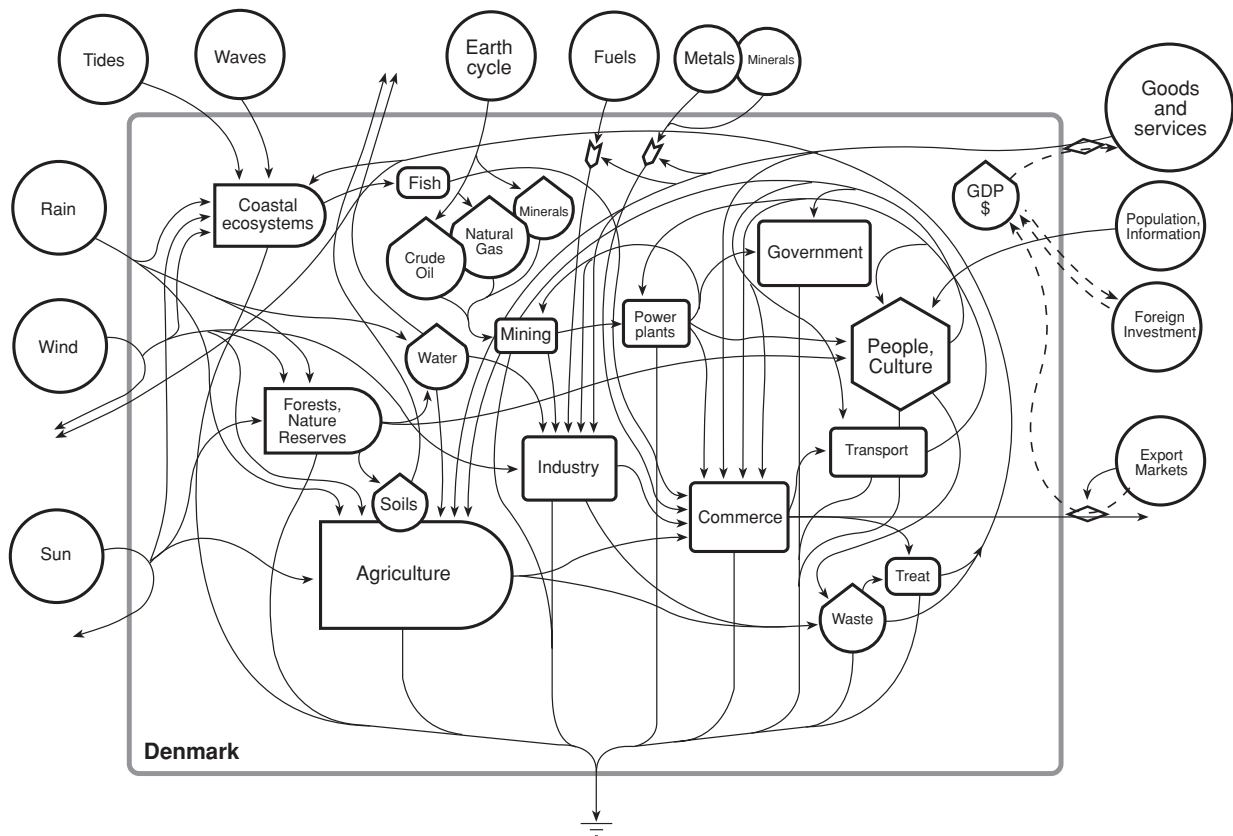

Figure 4.2. Energy systems overview diagram of the Danish economy. While the diagram is of the modern economy, omitting the mining of fossil energy from within Denmark makes the diagram appropriate to all years studied (adapted from Odum, 1996).



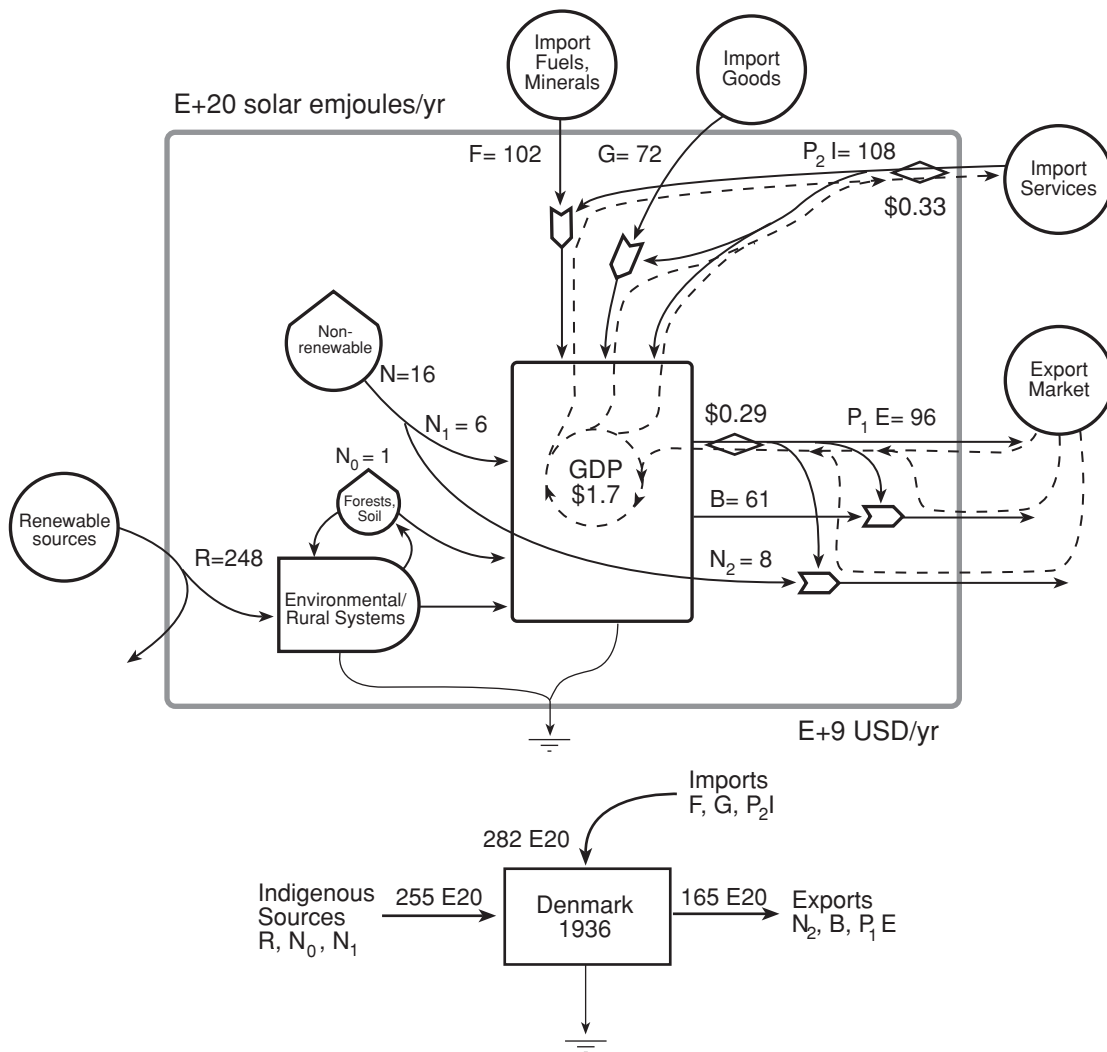

Figure 4.3. Aggregated systems diagram summarizing all emergy flows for the Danish economy for 1936.

#### 4.1.2 Emergy Analysis of Denmark, 1936

The first year evaluated was 1936, and was chosen because this was the first year for which reliable records were available for both the economy and for agriculture. Figure 4.3 is a summary diagram indicating all resource flows imported and exported from Denmark and those resources originating from within Denmark for the year 1936. Adjacent to the arrows, which indicate pathways of emergy flow, are figures indicating the total flows supporting the Danish economy. The emergy flows are aggregated for simplicity within the categories outlined in section 3.2. All emergy flow data is in units of solar emergy joules and has been divided by  $10^{20}$ . The dashed lines indicate the flow of money through the system. Table 4.1 summarizes the emergy flows for Denmark in 1936. Table 4.2 is a comprehensive table showing all emergy flows evaluated for 1936.

The basis of long-term sustainability for a society is limited to the emergy sources that are locally available. In this regard, the renewable emergy (R) supporting the Danish economy in 1936 totaled  $248.43 \text{ E}+20 \text{ sej/yr}$  and was primarily in the form wave emergy in the coastal areas and rain emergy inland. Locally available non-renewable emergy sources in 1936 were modest compared with other nations in Europe and the world. The local non-renewable emergy (N) supporting Denmark in 1936 totaled  $15.65 \text{ E}+20 \text{ sej/yr}$ , and consisted primarily of gravel, sand and limestone which was used domestically and exported. Imported fuels and minerals (F) totaled  $102.82 \text{ E}+20 \text{ sej/yr}$  representing a major emergy source for the 1936 Danish economy. Of the total,  $74.26 \text{ E}+20 \text{ sej/yr}$  was in the form of imported coal. At this time, coal was the main fuel source powering the newly developing industrial manufacturing sectors and was used to run steam engines for electricity generation and the transportation sector, as well as for space heating. Imported goods (G) including metals, agriculture and livestock products, rubber and plastic goods, chemicals, wood, paper, textiles and machinery totaled  $71.53 \text{ E}+20 \text{ sej/yr}$  and contributed considerable emergy to the Danish economy, rivaling coal in importance. Of the total (G),  $51.76 \text{ E}+20 \text{ sej/yr}$  was in the form of food and agriculture products, with much of this in the form of grain and fodder concentrates for animal feed to support the Danish livestock production sectors. This flow highlights the importance of agriculture to the Danish economy at this time. The emergy of services ( $P_2I$ ) that are embodied in the imported fuels, minerals and goods also represent a large emergy source for Denmark in 1936 at  $109.97 \text{ E}+20 \text{ sej/yr}$ . This flow represents the paid work of human beings outside of Denmark that have contributed to the Danish economy in this year through trade.

In terms of exports, the emergy exported from Denmark without further use ( $N_2$ ) was limited, totaling only  $7.29 \text{ E}+20 \text{ sej/yr}$ . When compared with exported products transformed within Denmark (B), which totaled  $60.95 \text{ E}+20 \text{ sej/yr}$ , it is clear that Denmark was stimulating its own economy by utilizing both imported and local emergy sources to upgrade and add value to products before exporting them. Of the total export products transformed within Denmark (B),  $51.94 \text{ E}+20 \text{ sej/yr}$  was in the form of livestock products, primarily processed meats and dairy products, again signaling the importance of livestock husbandry to the Danish economy at this time. When compared with the  $51.76 \text{ E}+20 \text{ sej/yr}$  imported emergy in grains and plant products - a roughly equivalent figure - it is clear that Danish livestock production had already transitioned from production for local consumption to production intended for export, and functioned in many ways as a throughput industry. The emergy balance of trade for Denmark in 1936, expressed as  $(F+G+P_2I)-(N_2+B+P_1E)$  indicates that Denmark imported  $1.16 \text{ E}+20 \text{ sej/yr}$  more emergy than it exported. Thus, trade was a stimulating force for the Danish economy at this time.

Table 4.1. Summary of emergy flows for Denmark, 1936.

Variable	Item	Units	Quantity
R	Renewable sources (rain, tide, waves)	$\text{E}+20 \text{ sej/yr}$	248.43
N	Nonrenewable resources from within Denmark	$\text{E}+20 \text{ sej/yr}$	15.65
$N_0$	Dispersed rural source	$\text{E}+20 \text{ sej/yr}$	1.34
$N_1$	Concentrated use	$\text{E}+20 \text{ sej/yr}$	6.41
$N_2$	Exported without use	$\text{E}+20 \text{ sej/yr}$	7.89
F	Imported fuels and minerals	$\text{E}+20 \text{ sej/yr}$	102.82
G	Imported goods	$\text{E}+20 \text{ sej/yr}$	71.53
$P_2I$	Emergy of services in imported goods & fuels	$\text{E}+20 \text{ sej/yr}$	107.65
$P_1E$	Emergy of exports goods and service	$\text{E}+20 \text{ sej/yr}$	99.00
B	Exported products transformed within Denmark	$\text{E}+20 \text{ sej/yr}$	60.95
E	Dollars received for exports	USD	$2.95\text{E}+08$
I	Dollars paid for imports	USD	$3.30\text{E}+08$
X	Gross domestic product	USD	$1.65\text{E}+09$
$P_2$	World emergy/\$ ratio, used in imports	sej/USD	$3.26\text{E}+13$
$P_1$	Denmark emergy/\$ ratio	sej/USD	$3.26\text{E}+13$

Table 4.2. Energy analysis of Denmark, 1936. Footnotes in Appendix B.

NOTE	Item, units	Data (units/year)	Transformity (sej/unit)	Ref. for transform.	Solar energy (E+20 sej/yr)
RENEWABLE RESOURCES:					
1	Sunlight, J	3.31E+20	1.00E+00	A	3.31
2	Wind, kinetic energy, J	5.77E+14	1.50E+03	A	0.01
3	Rain, chemical, J	2.90E+17	1.82E+04	A	52.72
4	Rain, geopotential, J	2.41E+15	2.79E+04	A	0.67
5	Waves, J	6.28E+17	3.06E+04	A	191.85
6	Tide, J	2.29E+16	1.68E+04	A	3.86
7	Earth cycle, J	4.31E+16	3.44E+04	A	14.81
INDIGENOUS RENEWABLE ENERGY:					
8	Agriculture production, J	1.64E+17	3.66E+04	G	60.08
9	Livestock production, J	2.28E+16	3.44E+05	G	78.69
10	Forest extraction, J	1.31E+16	6.60E+03	C	0.86
NONRENEWABLE SOURCES FROM WITHIN SYSTEM:					
11	Coke, J	8.76E+15	4.00E+04	A	3.50
12	Calcium carbonate, g	3.87E+10	1.00E+09	A	0.39
13	Minerals, g	1.04E+12	1.00E+09	A	10.40
14	Top soil, J	6.51E+14	7.40E+04	A	0.48
IMPORTS AND OUTSIDE SOURCES:					
15	Coal, J	1.86E+17	4.00E+04	A	74.26
16	Crude oil, J	1.27E+16	5.40E+04	A	6.83
17	Gas/fuel oil, J	1.20E+16	6.60E+04	A	7.95
18	Oil derived products, J	7.74E+15	6.60E+04	A	5.11
19	Metals, g	5.49E+11	9.20E+08	D	5.05
20	Minerals, g	3.62E+11	1.00E+09	A	3.62
21	Food & agriculture products, J	2.59E+16	2.00E+05	F	51.76
22	Livestock, meat, fish, J	3.66E+14	2.00E+06	F	7.32
23	Fisheries production, J	3.64E+14	1.20E+06	H	4.37
24	Plastics & rubber, g	6.87E+09	3.80E+08	D	0.03
25	Chemicals, g	5.80E+11	3.80E+08	D	2.20
26	Wood, paper, textiles, J	1.11E+16	3.49E+04	G*	3.89
27	Mechanical & transport. equip., g	2.92E+10	6.70E+09	D	1.96
28	Service in imports, USD	3.30E+08	3.33E+13	G	107.65
EXPORTS:					
29	Metals, g	1.20E+11	9.20E+08	D	1.11
30	Minerals, g	6.14E+11	1.00E+09	A	6.14
31	Food & agriculture products, J	4.46E+15	2.00E+05	F	8.92
32	Livestock, meat, fish, J	2.60E+15	2.00E+06	F	51.94
33	Wood, paper, textiles, J	6.80E+14	3.49E+04	D	0.24
34	Chemicals, g	9.76E+10	3.80E+08	D	0.37
35	Plastics & rubber, J	2.71E+10	3.80E+08	D	0.10
36	Mechanical & transport. equip., g	3.43E+08	6.70E+09	D	0.02
37	Service in exports, USD	2.95E+08	3.36E+13	G	96.00

### 4.1.3 Energy Analysis of Denmark, 1970

To facilitate comparison, the resource basis of the Danish economy was evaluated for the year 1970. The evaluation indicates that the total renewable energy (R) supporting the combined system of ecology and economy in Denmark was essentially unchanged from 1936, at  $256.42 \text{ E}+20$  sej/yr. Likewise, the total non-renewable energy sources from within Denmark (N) was little changed at  $30.50 \text{ E}+20$  sej/yr. As in 1936, most of this energy was in the form of raw minerals, such as gravel, sand and cement. Also like 1936, a similar portion of the total locally available non-renewable energy (N) was exported in its raw form, without further use. In terms of imports, in 1970, Denmark imported  $633.23 \text{ E}+20$  sej/yr of fuels and minerals (F), primarily in the form of crude oil and its derivatives. This represents a large increase over 1936, and crude oil imports were a tremendous stimulus to the Danish economy and the lifestyle of the Danish people in 1970. Coal, metals and minerals, representing  $42.88 \text{ E}+20$  sej/yr,  $17.10 \text{ E}+20$  sej/yr and  $24.27 \text{ E}+20$  sej/yr respectively, were also important energy sources for the economy and were used primarily in the industrial manufacturing sector that had grown substantially in Denmark since 1936. Imported goods (G), at  $225.56 \text{ E}+20$  sej/yr were also important for the Danish population, indicating a substantial increase in overall societal metabolism of consumer goods, which corresponds to an increase in what is usually thought of as "standard of living" or "quality of life". Attendant to the increased importation of fuels, minerals and goods was a large increase in the importation of energy in the form of human labor and service ( $P_2I$ ) that accompany these imports, totaling  $460.38 \text{ E}+20$  sej/yr.

In terms of exports, Denmark was exporting  $301.14 \text{ E}+20$  sej/yr in finished and partially finished products transformed by Danish industries, indicated in Table 4.3 as variable (B). Of the total,  $174.06 \text{ E}+20$  sej/yr was in the form of agricultural and livestock products, with 78% of that being in the form of meat and dairy products. This indicates a continued importance of the agricultural sector to generate foreign exchange for the Danish economy. Accompanying the exportation of goods is the energy of the human work performed within Denmark to get the exported goods to market ( $P_1E$ ). In 1970, Denmark exported energy in human services totaling  $344.92 \text{ E}+20$  sej/yr. In terms of macroeconomic indicators, the gross domestic product of Denmark increased 823% during the period from 1936 to 1970, from \$1,650,000,000 USD to \$15,200,000,000 USD. However, the energy flow per unit currency fell by 68% during the same period.

Figure 4.4 is an overview diagram indicating all resource flows imported and exported from Denmark and those resources originating from within Denmark, as listed in Table 4.3. The diagram provides a visual comparison to the total energy flows of the Danish economy in 1936 and 1999 which are shown in Figures 4.3 and 4.5 respectively. Table 4.4 is a detailed energy analysis, from which the aggregated data in Figure 4.4 and Table 4.3 was drawn.

Table 4.3. Summary of energy flows for Denmark, 1970.

Variable	Item	Units	Quantity
R	Renewable sources (rain, tide, waves)	E+20 sej/yr	256.42
N	Nonrenewable resources from within Denmark	E+20 sej/yr	30.50
N <sub>0</sub>	Dispersed rural source	E+20 sej/yr	1.70
N <sub>1</sub>	Concentrated use	E+20 sej/yr	21.46
N <sub>2</sub>	Exported without use	E+20 sej/yr	7.35
F	Imported fuels and minerals	E+20 sej/yr	633.23
G	Imported goods	E+20 sej/yr	225.56
P <sub>2</sub> I	Emergy of services in imported goods & fuels	E+20 sej/yr	460.38
P <sub>1</sub> E	Emergy value of goods and service exports	E+20 sej/yr	344.92
B	Exported products transformed within Denmark	E+20 sej/yr	301.14
E	Dollars received for exports	USD	3.29E+09
I	Dollars paid for imports	USD	4.38E+09
X	Gross domestic product	USD	1.52E+10
P <sub>2</sub>	World energy/\$ ratio, used in imports	sej/USD	1.05E+13
P <sub>1</sub>	Denmark energy/\$ ratio	sej/USD	1.05E+13

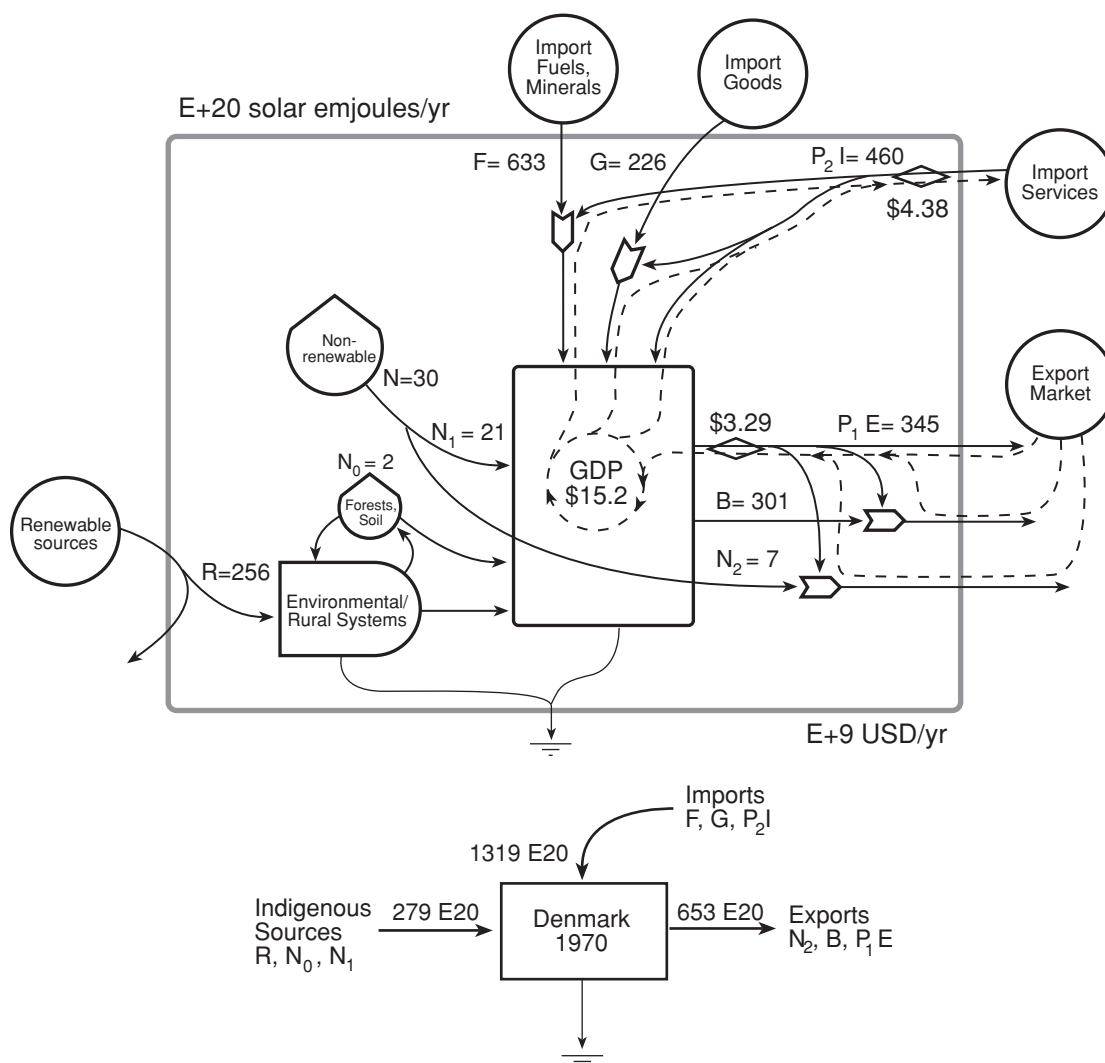

Figure 4.4. Systems overview diagram summarizing all resource flows for the Danish economy for 1970.

Table 4.4. Energy flows for Denmark, 1970. Footnotes in Appendix B.

NOTE	Item, units	Data (units/year)	Transformity (sej/unit)	Ref. for transform.	Solar energy (E+20 sej/yr)
RENEWABLE RESOURCES:					
	1 Sunlight, J	3.31E+20	1.00E+00	A	3.31
	2 Wind, kinetic energy, J	5.77E+14	1.50E+03	A	0.01
	3 Rain, chemical, J	3.34E+17	1.82E+04	A	60.70
	4 Rain, geopotential, J	3.67E+15	2.79E+04	A	1.02
	5 Waves, J	6.28E+17	3.06E+04	A	191.85
	6 Tide, J	2.29E+16	1.68E+04	A	3.86
	7 Earth cycle, J	4.31E+16	3.44E+04	A	14.81
INDIGENOUS RENEWABLE ENERGY:					
	8 Renewable energy, J	1.51E+15	6.60E+03	A	0.10
	9 Agricultural production, J	2.14E+17	6.25E+04	G	133.77
	10 Livestock production, J	3.63E+16	3.44E+05	G	124.96
	11 Forest extraction, J	1.21E+16	6.60E+03	C	0.80
NONRENEWABLE SOURCES FROM WITHIN SYSTEM:					
	12 Oil, J	8.91E+15	5.40E+04	A	4.81
	13 Coal, J	2.90E+15	4.00E+04	A	1.16
	14 Metals, g	5.41E+09	1.00E+09	A	0.05
	15 Minerals, g	2.28E+12	1.00E+09	A	22.78
	16 Top soil, J	1.21E+15	7.40E+04	A	0.90
IMPORTS AND OUTSIDE SOURCES:					
	17 Coal, J	1.07E+17	4.00E+04	A	42.88
	18 Crude oil, J	4.51E+17	5.40E+04	A	243.39
	19 Gas/fuel oil, J	3.23E+17	6.60E+04	A	212.95
	20 Oil derived products, J	1.40E+17	6.60E+04	A	92.64
	21 Metals, g	1.86E+12	9.20E+08	D	17.10
	22 Minerals, g	2.43E+12	1.00E+09	A	24.27
	23 Food & agriculture products, J	2.84E+16	2.00E+05	F	56.85
	24 Livestock, meat, fish, J	1.87E+15	2.00E+06	F	37.33
	25 Fisheries production, J	5.19E+15	1.20E+06	H	62.30
	26 Plastics & rubber, g	3.33E+11	3.80E+08	D	1.27
	27 Chemicals, g	1.71E+12	3.80E+08	D	6.50
	28 Wood, paper, textiles, J	2.94E+16	3.49E+04	G*	10.25
	29 Mechanical & transport. equip., g	7.62E+11	6.70E+09	D	51.06
	30 Service in imports, USD	4.38E+09	1.05E+13	A	460.38
	31 Tourism, USD	2.60E+08	1.05E+13	A	27.29
EXPORTS:					
	32 Coal	6.68E+11	5.30E+04	A	0.00
	33 Crude oil	8.02E+11	5.40E+04	A	0.00
	34 Gas/fuel oil, J	3.55E+16	6.60E+04	A	23.41
	35 Oil derived products, J	4.13E+16	6.60E+04	A	27.24
	36 Metals, g	4.03E+11	9.20E+08	D	3.71
	30 Minerals, g	3.97E+12	1.00E+09	A	39.71
	31 Food & agriculture products, J	1.91E+16	2.00E+05	F	38.11
	32 Livestock, meat, fish, J	6.80E+15	2.00E+06	F	135.95
	33 Wood, paper, textiles, J	1.01E+16	3.49E+04	D	3.52
	34 Chemicals, g	2.67E+11	3.80E+08	D	1.02
	36 Mechanical & transport. equip., g	5.30E+11	6.70E+09	D	35.52
	35 Plastics & rubber, g	7.98E+10	3.80E+08	D	0.30
	37 Service in exports, USD	3.29E+09	1.04E+13	G	344.92

#### 4.1.4 Emergy Analysis of Denmark, 1999

Following the same procedure as for the years 1936 and 1970, the year 1999 was evaluated to gain an up-to-date understanding of the total resource use supporting the modern Danish economy. The analysis showed that the renewable emergy flow (R) supporting the Danish economy in 1999 was again essentially unchanged from previous years, at  $257.18 \text{ E}+20 \text{ sej/yr}$ . A striking increase over previous years appears in the total amount of non-renewable emergy (N) that originated from within Denmark, which registered  $974.17 \text{ E}+20 \text{ sej/yr}$  for 1999. The primary reason for this dramatic increase is due to the fact that, between 1970 and 1999, Denmark began to exploit oil and natural gas reserves in the portion of the North Sea that falls within its territorial waters. This discovery, and subsequent exploitation, allowed Denmark to become essentially self-sufficient in hydrocarbon fossil fuels. Another substantial portion of (N) was in the form of minerals, mainly cement, sand and gravel. The large increase in the amount of minerals used during this time is difficult to account for. While a change in accounting methods by the national statistics bureau may explain some of the increase, a plausible explanation is that during this period, the Øresund bridge between Sweden and Denmark was being constructed and required a large excavation of sand and gravel for its construction. The bridge required the construction of a massive artificial island (approximately 4-km long), the world's longest submerged tunnel (3.5 km) and a 7.85 km long suspension bridge, all of which required large quantities of stone and gravel as fill. Of the non-renewable emergy (N) resources recovered in 1999, the amount used within Denmark ( $N_1$ ) was approximately  $821.81 \text{ E}+20 \text{ sej/yr}$ . Clearly, the emergy flow from these storages greatly stimulated the Danish economy. Table 4.5 and Figure 4.5 indicate the aggregated emergy flows for the Danish economy in 1999.

Imported fuels and minerals (F) increased significantly from 1970 to 1999 registering  $569.73 \text{ E}+20 \text{ sej/yr}$  in 1999. Likewise, imported goods (G), at  $504.13 \text{ E}+20 \text{ sej/yr}$  indicates a high material standard of living with ample access to consumer goods for the modern Danish citizen. Attending the import of fuels and goods to Denmark was a substantial amount of emergy in human service ( $P_2I$ ), which in 1999 totaled  $868.56 \text{ E}+20 \text{ sej/yr}$ .

With regard to exports in 1999, the amount of emergy exported in products that were transformed within Denmark before being exported (B) was  $790.89 \text{ E}+20 \text{ sej/yr}$ . The emergy in human services that was exported with products ( $P_1E$ ) totaled  $852.94 \text{ E}+20 \text{ sej/yr}$ . Due to the export of fossil energy resources, the amount of non-renewable emergy exported from Denmark without further use ( $N_2$ ) also increased to  $149.28 \text{ E}+20 \text{ sej/yr}$ . Table 4.6 is a detailed emergy analysis of the Danish economy for 1999.



Table 4.5. Summary of resource flows for Denmark, 1999.

Variable	Item	Units	Quantity
R	Renewable sources (rain, tide, waves)	E+20 sej/yr	257.18
N	Nonrenewable resources from within Denmark	E+20 sej/yr	974.17
$N_0$	Dispersed rural source	E+20 sej/yr	3.09
$N_1$	Concentrated use	E+20 sej/yr	821.81
$N_2$	Exported without use	E+20 sej/yr	149.28
F	Imported fuels and minerals	E+20 sej/yr	569.73
G	Imported goods	E+20 sej/yr	504.13
$P_2 I$	Energy of services in imported goods & fuels	E+20 sej/yr	868.56
$P_1 E$	Energy value of goods and service exports	E+20 sej/yr	852.94
B	Exported products transformed within Denmark	E+20 sej/yr	790.89
E	Dollars received for exports	USD	4.95E+10
I	Dollar paid for imports	USD	4.45E+10
X	Gross domestic product	USD	1.76E+11
$P_2$	World energy/\$ ratio, used in imports	sej/USD	1.95E+12
$P_1$	Denmark energy/\$ ratio	sej/USD	1.72E+12

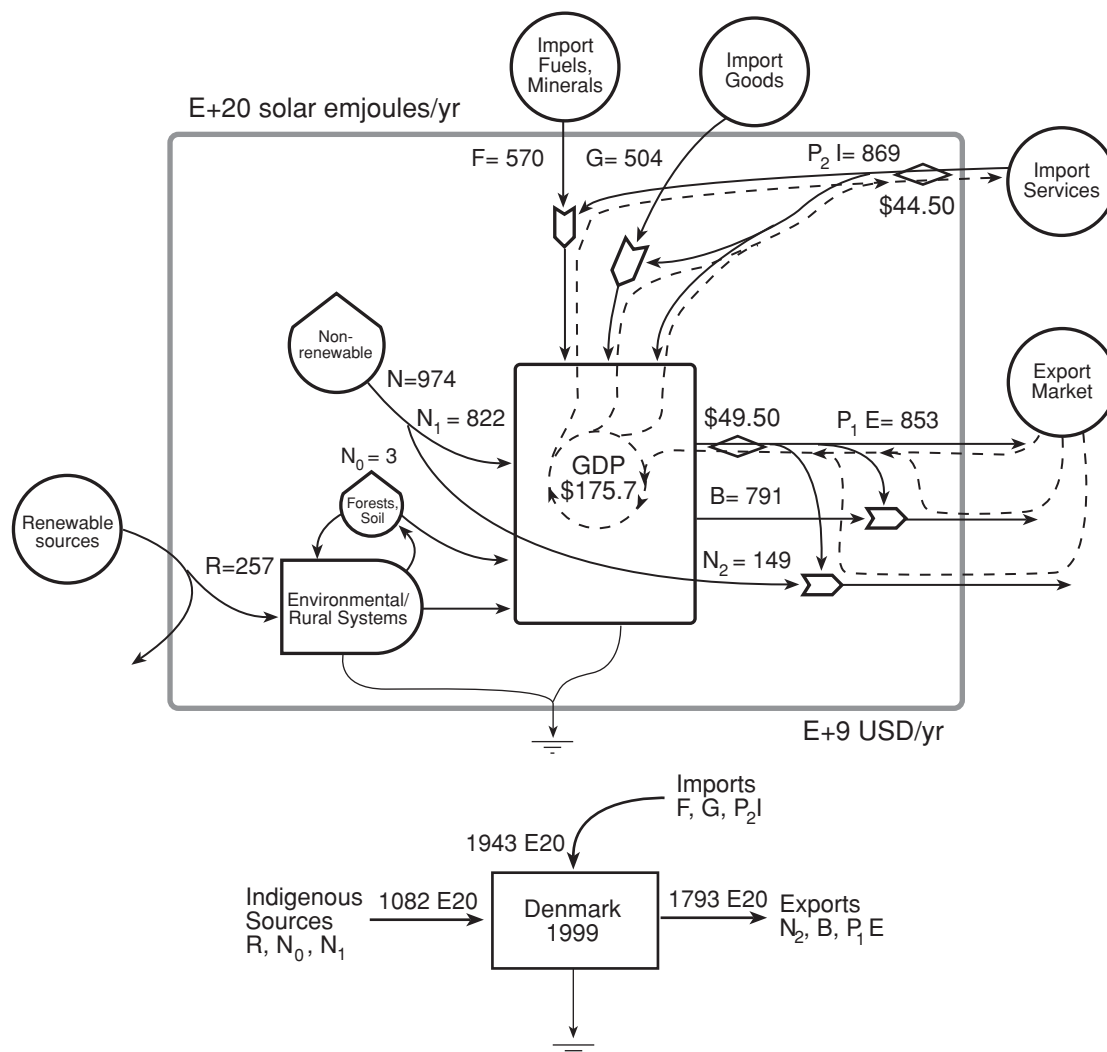

Figure 4.5. Systems overview diagram summarizing all resource flows for the Danish economy for 1999.

Table 4.6. Emergy analysis of Denmark, 1999. Footnotes in Appendix B.

NOTE	Item, units	Data (units/year)	Transformity (sej/unit)	Ref. for transform.	Solar emergy (E+20 sej/yr)
RENEWABLE RESOURCES:					
1	Sunlight, J	3.31E+20	1.00E+00	A	3.31
2	Wind, kinetic energy, J	6.80E+14	1.50E+03	A	0.01
3	Rain, chemical, J	3.38E+17	1.82E+04	A	61.47
4	Rain, geopotential, J	3.77E+15	2.79E+04	A	1.05
5	Waves, J	6.28E+17	3.06E+04	A	191.85
6	Tide, J	2.29E+16	1.68E+04	A	3.86
7	Earth cycle, J	4.31E+16	3.44E+04	A	14.81
INDIGENOUS RENEWABLE ENERGY:					
8	Renewable energy, J	8.10E+16	1.35E+05	A	109.61
9	Agricultural production, J	2.36E+17	4.07E+04	G	96.13
10	Livestock production, J	4.56E+16	2.13E+05	G	97.27
11	Forest extraction, J	1.10E+16	6.60E+03	C	0.72
NONRENEWABLE SOURCES FROM WITHIN SYSTEM:					
12	Natural gas, production, J	2.78E+17	4.80E+04	A	133.23
13	Natural gas, consumption, J	1.55E+17	4.80E+04	A	74.44
14	Oil, production, J	6.65E+17	5.40E+04	A	359.27
15	Oil, consumption, J	4.98E+17	5.40E+04	A	268.79
16	Calcium carbonate, g	3.34E+12	1.00E+09	A	33.43
17	Minerals, g	4.45E+13	1.00E+09	A	445.15
18	Top soil, J	3.19E+15	7.40E+04	A	2.36
IMPORTS AND OUTSIDE SOURCES:					
19	Coal, J	2.28E+17	4.00E+04	A	91.32
20	Crude oil, J	4.51E+17	5.40E+04	A	243.39
21	Oil derived products, J	2.14E+17	6.60E+04	A	141.17
22	Metals, g	3.25E+12	9.20E+08	D	29.90
23	Minerals, g	6.39E+12	1.00E+09	A	63.95
24	Food & agriculture products, J	6.99E+16	2.00E+05	F	139.79
25	Livestock, meat, fish, J	6.74E+15	2.00E+06	F	134.81
26	Fisheries production, J	5.71E+15	1.20E+06	H	68.53
27	Plastics & rubber, g	1.02E+12	3.80E+08	D	3.87
28	Chemicals, g	3.05E+12	3.80E+08	D	11.59
29	Wood, paper, textiles, J	7.24E+16	4.40E+04	G*	31.87
30	Mechanical & transport. equip., g	1.70E+12	6.70E+09	D	113.67
31	Service in imports, USD	4.45E+10	1.95E+12	G	868.56
32	Tourism, USD	3.07E+09	1.73E+12	G	53.15
EXPORTS:					
33	Coal	6.42E+15	4.00E+04	A	2.57
34	Crude oil	4.02E+17	5.40E+04	A	216.85
35	Gas/fuel oil, J	1.87E+17	6.60E+04	A	123.11
36	Oil derived products, J	1.10E+17	4.80E+04	A	52.77
37	Metals, g	2.74E+12	9.20E+08	D	25.22
38	Minerals, g	4.97E+12	1.00E+09	A	49.66
39	Food & agriculture products, J	6.91E+16	2.00E+05	F	138.19
40	Livestock, meat, fish, J	1.41E+16	2.00E+06	F	281.82
41	Wood, paper, textiles, J	2.74E+16	4.40E+04	G*	12.06
42	Chemicals, g	1.43E+13	3.80E+08	D	54.51
43	Mechanical & transport. equip., g	1.57E+12	6.70E+09	D	105.50
44	Plastics & rubber, g	2.13E+11	3.80E+08	D	0.81
45	Service in exports, USD	4.95E+10	1.72E+12	G	852.94

## 4.2 Emergy Evaluations of Danish Agriculture

In order to understand the importance of agriculture, in emergy terms, to the economy of Denmark, the Danish agricultural system was evaluated as a whole for the years 1936, 1970 and 1999 using the same procedures as for the evaluations of the Danish economy. As a major subsystem of the Danish national economy, agriculture is also the primary activity through which the people of Denmark access the land-based, renewable energy flows indigenous to their nation. By measuring the emergy flowing to agriculture, and from agriculture, to the surrounding society, an understanding of the role agriculture plays in the overall Danish economy was obtained. Figure 4.6 is an overview energy systems diagram of Danish agriculture. The diagram is intended to serve as a general diagram for all years evaluated.

The Danish agricultural system, as evaluated here, consists of farm owners and employed laborers; cultivated and permanent pasture lands and their topsoil; farm buildings and machinery; locally available renewable energy sources, such as sun, wind and rain; purchased inputs; as well as the human service that is embodied in these purchased inputs. The energy output of each year was evaluated as the gross production of crops and livestock products converted into energy units (J). The spatial boundary of the system was limited to the area of land in agricultural production for each year, which has shrunk over the period studied.

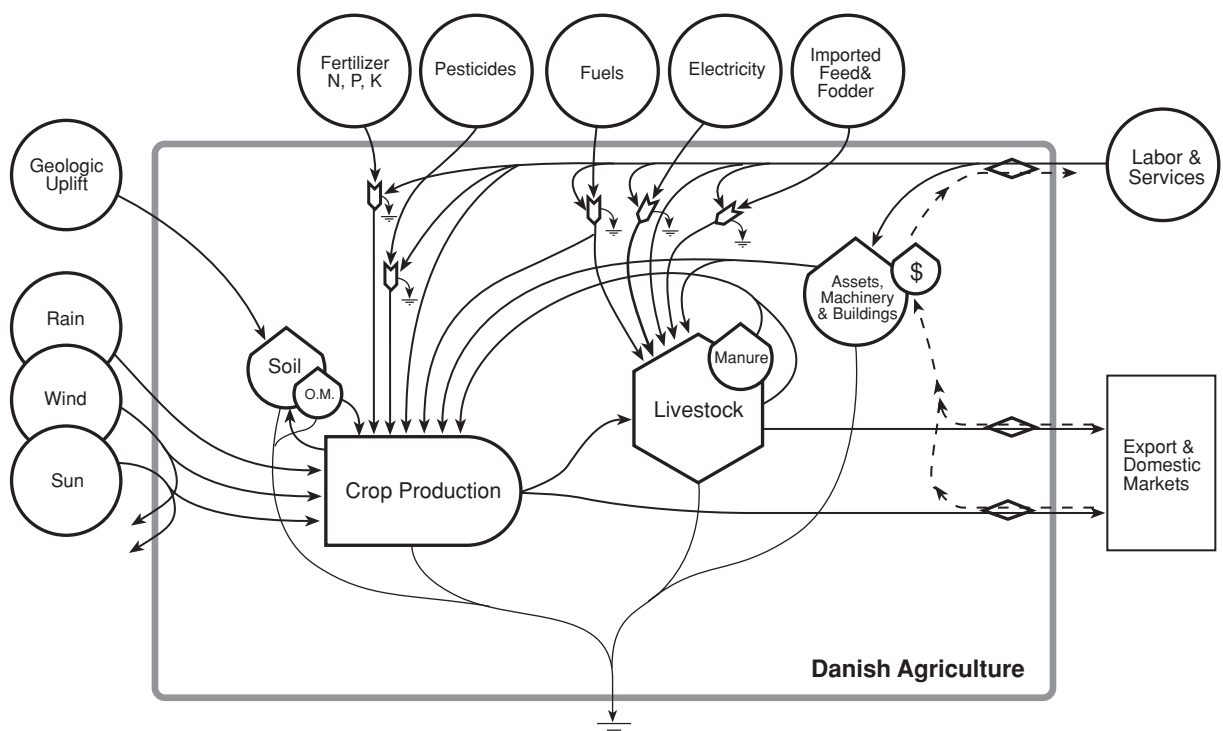

Figure 4.6. Overview energy systems diagram of the Danish agricultural system.

### 4.2.1 Emergy Analysis of Danish Agriculture 1936

In 1936, Danish agriculture was largely based on the use of draft animals for traction, but was nonetheless highly dependent upon outside imports and services to achieve its productivity. 1936 falls within the time period that has been referred to as the classical period of agriculture in Denmark, as livestock cooperatives were strong and over 500,000 people were directly engaged in agricultural production (Ingemann, 1999; Statistics Denmark, 1937). Being oriented toward export markets, agricultural production was already functioning as something of a throughput industry and was a primary source of foreign exchange for Denmark at this time. In 1936, The Danish agricultural system relied on renewable emergy flows (R) totaling  $17.86 \text{ E}+20$  sej, with most of this in the form of rain. Soil erosion amounted to  $0.48 \text{ E}+20$  sej and was the locally available non-renewable storage (N) that was an input to production. Purchased inputs (P) were a major force driving productivity. However, the applied supplementary energy sources were relatively small at this time, with  $2.72 \text{ E}+20$  sej of electricity and fuel used in production.

Table 4.7 is a summary table of the emergy flows supporting Danish agricultural production in 1936. Figure 4.7 is an aggregated diagram of the Danish agricultural system for the same year. The use and depreciation of farm assets contributed  $6.19 \text{ E}+20$  sej to production and, while draft animal power was the primary source of traction, there were over 5,000 steam engine tractors in operation and hundreds of thousands of steel farm implements used in both crop and livestock production. These implements include seed drills, mowing machines, harvesters, reaper-binders, as well as milking machines and stationary grain threshers.

The purchased goods specific to crop production were in the form of commercial fertilizers and represent a major stimulus, in emergy terms, to agricultural production in this year. At  $13.20\text{E}+20$  sej, commercial phosphate, nitrogen and potash fertilizers were applied extensively, with phosphate fertilizer representing the largest emergy flow at  $11.63\text{E}+20$  sej. Goods for livestock production were also a large emergy input to agricultural production in 1936, equaling  $20.06\text{E}+20$  sej. Imported cereals for feed contributed  $7.93\text{E}+20$  sej; while imported high protein feed concentrates contributed  $12.13\text{E}+20$  sej. Human labor and services (S) represent the largest single input and because they are purchased, are considered an outside source of emergy. In 1936, the total value of crop production totaled \$402,000,000 USD. By multiplying this amount by an emergy/\$ ratio for the 1936 Danish economy of  $2.22\text{E}+13$  sej/USD, the total emergy contribution from human service was calculated to be  $89.41\text{E}+20$  sej. The emergy/\$ ratio was modified so that the emergy yielded to the economy from agriculture was subtracted from the total emergy/\$ ratio of the Danish economy at this time, to avoid double counting. The service and labor component is

measured with dollar costs, not metabolic energy, since money circulating in a system always purchases human services. This money is then used by people to purchase life-support energy in the economy. Table 4.8 shows the detailed energy analysis for 1936. The calculations for each item are shown in Appendix B.

Table 4.7. Summary table of the energy flows for Danish agriculture, 1936.

Name of flow	Quantity (E+20 sej)
Local renewable sources (R)	17.86
Local non-renewable sources (N)	0.48
Purchased resources (P)	42.17
Services and labor (S)	89.41
Feedback from economy (F = P + S)	131.58
Energy Yield (Y)	149.92

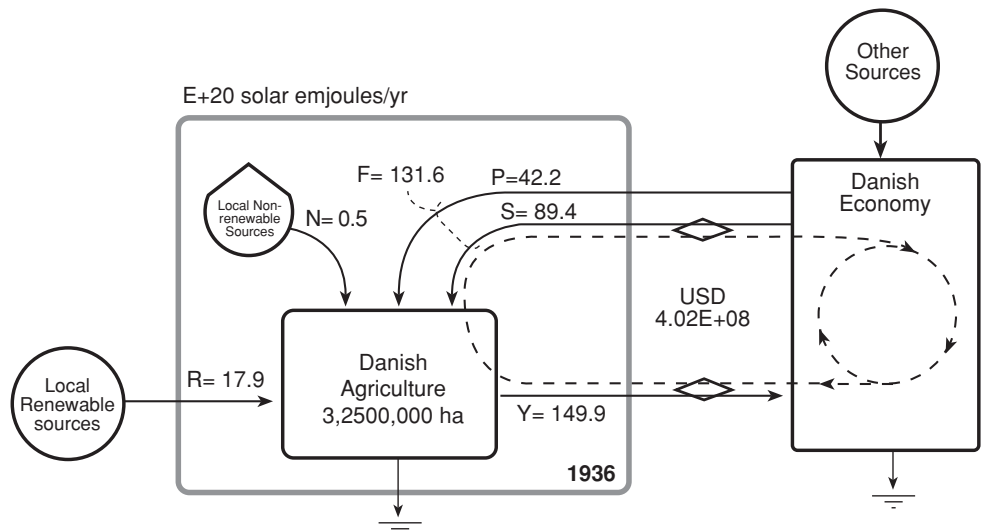

Figure 4.7. Overview diagram showing the main pathways of energy flows in Danish agriculture, 1936.

Table 4.8. Emergy analysis of Danish agriculture, 1936. Footnotes in Appendix B.

NOTE	Item, units	Data (units/year)	Transformity (sej/unit)	Ref. for transform.	Solar emergy (E+20 sej/yr)
RENEWABLE RESOURCES (R):					
1	Sun, J	7.62E+19	1	A	0.76
2	Wind, J	3.54E+14	1.50E+03	A	0.01
3	Rain, J	9.81E+16	1.82E+04	A	17.86
4	Earth cycle, J	3.25E+16	3.40E+04	E	11.05
NONRENEWABLE STORAGES (N):					
5	Net topsoil loss, J	6.51E+14	7.38E+04	A	0.48
PURCHASED INPUTS (P):					
<i>Applied energy</i>					
6	Fuel, J	9.75E+14	6.60E+04	A	0.64
7	Electricity, J	1.30E+15	1.60E+05	A	2.08
<i>Farm assets</i>					
8	Mechanical Equipment, g	2.21E+10	6.70E+09	D	1.48
9	Buildings, USD	2.12E+07	1.60E+13	G	4.71
<i>Goods for crop production</i>					
10	Potassium, g K	3.25E+10	1.10E+09	A	0.36
11	Phosphate, g P	6.53E+10	1.78E+10	A	11.63
12	Nitrogen, g N	3.19E+10	3.80E+09	A	1.21
<i>Goods for livestock production</i>					
13	Imported feed, cereals, J	1.17E+16	6.80E+04	D	7.93
14	Imported feed, concentrates, J	1.52E+16	8.00E+04	F	12.13
SERVICES (S):					
15	Services and labor, USD	4.02E+08	2.22E+13	G	89.41
CROP YIELD:					
16	Crop production, J	1.97E+17			
LIVESTOCK YIELD:					
17	Livestock production, J	2.28E+16			

#### 4.2.2 Emergy Analysis of Danish Agriculture 1970

The amount of locally available renewable and non-renewable emergy sources (R) supporting Danish agriculture in 1970 was little changed from 1936, and the system received 18.68 E+20 sej, with rain again being the dominant emergy flow. The amount of non-renewable emergy (N) that contributed to production in 1970 - in the form of soil erosion and used organic matter - increased 86% from 1936. The increase is assumed to be due to changes in cropping patterns towards winter crops, which are more prone to erosion (Schjønning, 1995). In 1970, Danish agriculture was fully mechanized. No draft horses were used in production and all traction was provided by tractors and most harvesting done by combined harvesters (Statistics Denmark, 1972; Schroll, 1994). Consequently, there was a dramatic increase in the quantity of purchased inputs (P) that needed to be imported from outside the sys-

tem. Large increases in P stemmed from the increase use of fuel and electricity, the use of which increased 345% from 1936 to 1970. Other large increases where from the contribution of farm assets (buildings and machinery) which expanded by 91% over the period from 1936 to 1970 and inputs of fertilizer and the introduction of pesticides which increased the total amount of purchased emergy flowing to crop production by 72% from 1936. Goods purchased for livestock production - primarily imported feed and feed concentrates - declined by 24% during the same period. Table 4.9 is summary of the emergy flows for Danish agriculture in 1970. Figure 4.8 is an energy systems diagram of the data.

Interestingly, while the amount of human labor that was directly involved in agricultural production decreased dramatically, from 559,726 people to 265,500 (Statistics Denmark, 1937, 1972), the emergy support provided from human labor and services increased almost two-fold (91%). The primary reason for this is that, in order to allow Danish farmers to enjoy the same quality of life as urban dwellers, with full access to the fossil fueled economy and its associated consumer goods, the Danish agricultural societies fought to ensure that farmers received a monetary income that was equal to that earned by those employed in urban sectors (Ingemann, 1999). Because the emergy flowing through the economy in 1970 was far greater than in 1936, the average salary of Danish citizens at that time purchased considerable emergy, which supported the overall rise in standard of living for farmers and non-farmers alike. Because emergy analysis employs a network perspective and considers that all the resources supporting human labor are a component of the production process, the emergy flowing to farm families and laborers, and to the industries that provide goods and services to the agricultural sector, are all considered to contribute to agricultural productivity and must be included in evaluations. Table 4.10 is an emergy analysis of 1970 Danish agriculture.

*Table 4.9. Summary table of the emergy flows for Danish agriculture, 1970.*

<b>Name of flow</b>	<b>Quantity (E+20 sej)</b>
Local renewable sources (R)	18.68
Local non-renewable sources (N)	0.89
Purchased resources (P)	73.40
Services and labor (S)	170.82
Feedback from economy (F = P + S)	244.22
Emergy Yield (Y)	263.79

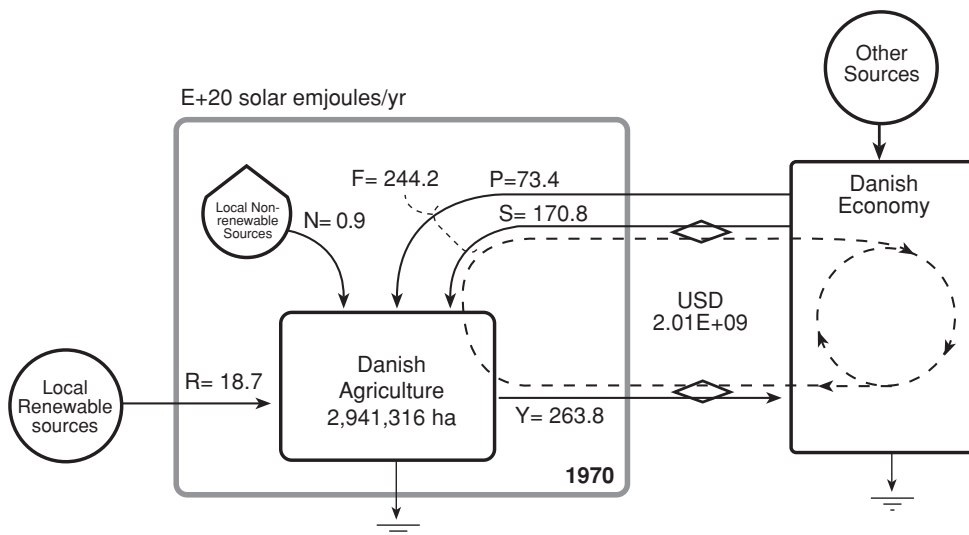

Figure 4.8. Systems overview diagram of Danish agriculture, 1970.

Table 4.10. Emergy analysis of Danish agriculture, 1970. Footnotes in Appendix B.

NOTE	Item, units	Data (units/year)	Transformity (sej/unit)	Ref. for transform.	Solar emergy (E+20 sej/yr)
RENEWABLE RESOURCES (R):					
1	Sun, J	7.62E+19	1	A	0.76
2	Wind, J	3.54E+14	1.50E+03	A	0.01
3	Rain, J	1.03E+17	1.82E+04	A	18.68
4	Earth cycle, J	2.94E+16	3.40E+04	E	10.00
NONRENEWABLE STORAGES (N):					
5	Net topsoil loss, J	1.21E+15	7.38E+04	A	0.89
PURCHASED INPUTS (P):					
<i>Applied energy</i>					
6	Fuel (petrol, kerosene, diesel), J	1.12E+16	6.60E+04	A	7.38
7	Electricity, J	8.82E+15	1.60E+05	A	14.12
<i>Farm assets</i>					
8	Mechanical Equipment, g	1.21E+11	6.70E+09	D	8.08
9	Buildings, USD	9.89E+07	8.48E+12	C	8.39
<i>Goods for crop production</i>					
10	Potassium, g K	1.52E+11	1.10E+09	A	1.67
11	Phosphate, g P	5.54E+10	1.78E+10	A	9.86
12	Nitrogen, g N	2.71E+11	3.80E+09	A	10.28
13	Pesticides, g	5.88E+09	1.50E+10	B	0.88
<i>Goods for livestock production</i>					
14	Imported feed, cereals, J	8.43E+15	6.80E+04	D	5.73
15	Imported feed, concentrates, J	1.19E+16	8.00E+04	F	9.52
SERVICES (S):					
16	Services and labor, USD	2.01E+09	8.48E+12	C	170.82
CROP YIELD:					
17	Crop production, J	2.15E+17			
LIVESTOCK YIELD:					
18	Livestock production, J	3.63E+16			



### 4.2.3 Emergy Analysis of Danish Agriculture 1999

In comparison to 1936 and 1970, the modern agricultural system of 1999 was highly mechanized, but employed fewer machines than 1970. Furthermore, it employed relatively few people compared to the previous years. Again, the renewable emery (R) flowing to agriculture in 1999 varied little at  $18.47 \text{ E}+20$  sej. The estimated loss of topsoil (N) during production increased by 164% from 1970, and was due to the large increase in winter grain farming. Purchased inputs (P) decreased by 8% in total from 1970. However, applied energy increased by 135% and goods for livestock increased 32%, while farm assets used in production decreased by 28% and the goods used for crop production decreased by 34% from 1970 levels. The applied energy inputs to Danish agriculture was the largest increase and in 1999, the mix of fuels used in agriculture was quite diversified with diesel, coal, gasoline, natural gas and electricity all contributing to production. The decrease in the use of farm assets (buildings and machinery) was likely due to a decrease in the number of tractors in use and a decrease in the number of working farms that required building maintenance. Figure 4.9 is a systems overview diagram with the flows of emery indicated for 1999.

In terms of direct and indirect human inputs to agriculture, the amount of services and labor contributing to agricultural production in 1999 decreased by 37% from 1970. There were fewer people directly employed in agriculture and the total feedback of emery from the economy to agriculture in the form of purchased services decreased. The amount of people directly engaged in agricultural production fell from 265,500 to 123,665. This decrease indicates the changing role of agriculture for the Danish economy to one of providing less of the empower (emery per unit time) needed to run the Danish economy. Section 4.3 goes into more detail about changes in the employment sectors of Denmark. Table 4.11 is a summary of the emery flows for Danish agriculture. Table 4.12 presents the detailed emery analysis from which these figures were drawn.

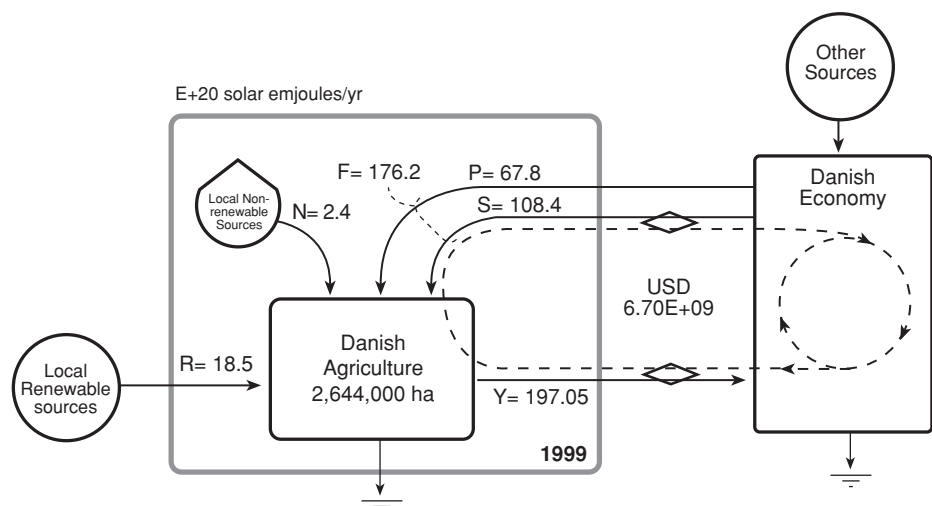

Figure 4.9. Systems overview diagram of Danish agriculture, 1999.

Table 4.11. Summary table of the emergy flows for Danish agriculture, 1999.

Name of flow	Quantity (E+20 sej)
Local renewable sources (R)	18.47
Local non-renewable sources (N)	2.36
Purchased resources (P)	67.80
Services and labor (S)	108.42
Feedback from economy (F = P + S)	176.22
Emergy Yield (Y)	197.05

Table 4.12. Emergy analysis of Danish Agriculture, 1999. Footnotes in Appendix B.

NOTE	Item, units	Data (units/year)	Transformity (sej/unit)	Ref. for transform.	Solar emergy (E+20 sej/yr)
RENEWABLE RESOURCES (R):					
	1 Sun, J	6.85E+19	1	A	0.68
	2 Wind, J	3.54E+14	1.50E+03	A	0.01
	3 Rain, J	1.01E+17	1.82E+04	A	18.47
	4 Earth cycle, J	2.64E+16	3.40E+04	E	8.99
NONRENEWABLE STORAGES (N):					
	5 Net topsoil loss, J	3.19E+15	7.38E+04	A	2.36
PURCHASED INPUTS (P):					
<i>Applied energy</i>					
	6 Diesel, J	2.17E+16	6.60E+04	A	14.34
	7 Coal, J	1.59E+15	4.00E+04	A	0.64
	8 Motor gasoline, J	9.42E+13	6.60E+04	A	0.06
	9 Fuel oil, J	2.75E+15	6.60E+04	A	1.82
	10 Natural gas, J	4.08E+15	4.80E+04	A	1.96
	11 Electricity, J	6.05E+15	1.60E+05	A	9.68
<i>Farm assets</i>					
	12 Mechanical Equipment, g	4.35E+10	6.70E+09	D	2.91
	13 Buildings, USD	7.77E+07	1.62E+12	G	1.26
<i>Goods for crop production</i>					
	14 Potassium, g K	8.09E+10	1.10E+09	A	0.89
	15 Phosphate, g P	2.03E+10	1.78E+10	A	3.61
	16 Nitrogen, g N	2.63E+11	3.80E+09	A	9.98
	17 Pesticides, g	3.62E+09	1.50E+10	B	0.54
<i>Goods for livestock production</i>					
	18 Imported feed, cereals, J	5.088E+14	6.80E+04	D	0.35
	19 Imported feed, concentrates, J	2.47E+16	8.00E+04	F	19.76
SERVICES (S):					
	20 Services and labor, USD	6.70E+09	1.62E+12	G	108.42
CROP YIELD:					
	21 Crop production, J	2.26E+17			
LIVESTOCK YIELD:					
	22 Livestock production, J	4.56E+16			

## **4.3 Comparative Indices**

### **4.3.1 The Danish Economy - Industrialization and Expansion**

The Danish economy is highly dependent upon external trade, and is fully embedded in the European and global economy. The analysis reveals that there has been a dramatic increase in the total energy used to support the economy of Denmark, as well as a large increase in the amount of energy exported from Denmark. Because the physical area of Denmark has remained fixed, and the major weather patterns that cross Denmark have been largely unchanged over the period of study, there has been no major changes in the renewable energy flows supporting the Danish economy. Thus, any increase in the standards of living, in energy terms, had to come from imported sources or from non-renewable storages. Over the period from 1936 to 1999, the Danish economy increased the overall throughput of both sources of energy and these flows have been responsible for the increase in economic growth during the same period. From 1936 to 1970, imported energy was largely responsible for the increase in total empower, while between 1970 to 1999, Denmark discovered and exploited indigenous non-renewable resources. This resulted in an energy self-sufficiency percentage, or the fraction of energy from home sources, to fall from 47% to 17% between 1936 to 1970 and then to rise to 36% by 1999.

While both the monetary economy and the use of energy expanded greatly from 1936 to 1999, a comparison of the total energy used in Denmark versus the GDP can make plain the fact that money does not measure real wealth. During the period studied, the GDP of Denmark increased over 10,000% while the total energy used, or the real wealth supporting the economy, increased by 460%. While the total increase in energy use was very large from 1936 to 1999, and the total increase in energy use per person was also impressive, rising approximately 290%, the energy to money ratio - a measure of the real wealth purchasing power of a currency - declined by 95% during the same period. Furthermore, as fuel use per person rose 679% from 1936 to 1999, the fraction of the energy supporting the economy that was from local renewable sources declined by 82%. Table 4.13 shows a comparison of some of the key energy-based indices calculated for this study, including the percent change in the ratio or flow, from year to year. Figure 4.10 is a graph showing the energy flows supporting the Danish economy over the years studied.

Table 4.13. Comparison of energy-based indices and ratios for the Danish Economy. All data sej/yr.

Name of Index, Expression	1936	1970	1999	Percentage change	
				1936 to 1970	1970 to 1999
Renewable energy flow, R	2.48E+22	2.56E+22	2.57E+22	3%	0%
Flow from indigenous nonrenewable reserves, N	1.57E+21	3.05E+21	9.74E+22	95%	3094%
Flow of imported energy, F+G+P <sub>2</sub> I	2.84E+22	1.32E+23	1.94E+23	364%	47%
Total energy inflows, R+N+F+G+P <sub>2</sub> I	5.48E+22	1.61E+23	3.17E+23	193%	98%
Total energy used, U (N <sub>0</sub> +N <sub>1</sub> +R+F+G+P <sub>2</sub> I)	5.41E+22	1.60E+23	3.02E+23	196%	89%
Total exported energy, N <sub>2</sub> +B+P <sub>1</sub> E	9.64E+21	3.45E+22	8.53E+22	258%	147%
Fraction energy use derived from home sources, (N <sub>0</sub> +N <sub>1</sub> +R)/U	0.47	0.17	0.36	-63%	105%
Imports minus exports, (F+G+P <sub>2</sub> I)-(N <sub>2</sub> +B+P <sub>1</sub> E)	1.19E+22	6.66E+22	1.49E+22	459%	-78%
Export to Imports, (N <sub>2</sub> +B+P <sub>1</sub> E)/(F+G+P <sub>2</sub> I)	0.58	0.50	0.92	-15%	86%
Imports to Exports, (F+G+P <sub>2</sub> I)/(N <sub>2</sub> +B+P <sub>1</sub> E)	1.72	2.02	1.08	17%	-46%
Fraction used, locally renewable, R/U	0.46	0.16	0.09	-65%	-47%
Fraction of use purchased, (F+G+P <sub>2</sub> I)/U	0.53	0.83	0.64	57%	-22%
Fraction imported service, P <sub>2</sub> I/U	0.20	0.29	0.29	42%	0%
Fraction of use that is free, (R+N <sub>0</sub> )/U	0.46	0.16	0.09	-65%	-47%
Empower density sej/ha/yr, U/(area in ha/yr)	1.25E+16	3.71E+16	7.02E+16	196%	89%
Fuel use per person, fuel/population	1.98E+15	1.11E+16	1.54E+16	460%	39%
Gross Domestic Product, in USD	1.65E+09	1.52E+10	1.76E+11	822%	1052%
Ratio of use to GDP, energy/\$ ratio, P <sub>1</sub> =U/GDP	3.27E+13	1.05E+13	1.72E+12	-68%	-84%
Use per person, U/population	1.46E+16	3.24E+16	5.69E+16	122%	76%
Renewable human carrying capacity at present living standard, (R/U) x (population)	1,703,512	791,934	451,832	-54%	-43%

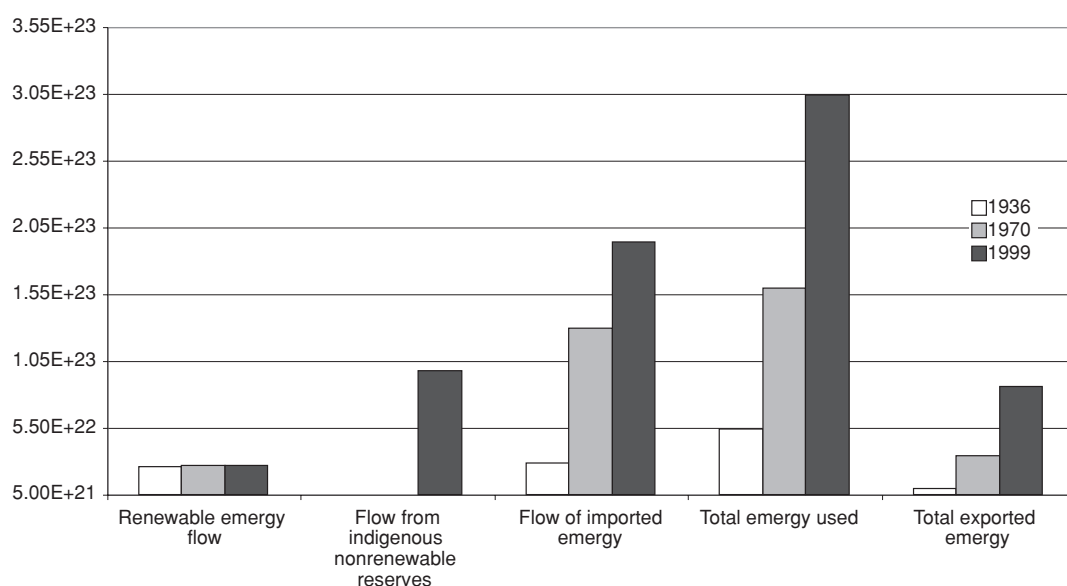

Figure 4.10. Graph showing a comparison of the total renewable, local non-renewable, imported and exported energy flows supporting the Danish economy in 1936, 1970 and 1999. All data sej/yr.

### **4.3.2 Energy-Based Sustainability Indices of the Danish Economy**

Because the increases in economic prosperity that Denmark has enjoyed have been based on large increases in non-renewable resource use and the importation of energy in goods and services, the sustainability of the Danish economy has seen a dramatic decrease, while its overall empower (energy per unit time) has increased. Table 4.14 presents the changes that have occurred in energy-based sustainability indices of the national economy of Denmark. While the Energy Yield Ratio (EYR) of the economy has fluctuated within a relatively small range, the Environmental Load Ratio (ELR) has increased dramatically, driving the Sustainability Index (SI) down commensurately. Also shown is an energy-based Energy Footprint Ratio that indicates the resources appropriated by Denmark through trade and from non-renewable storages.

Figure 4.11 is a graph showing the changes registered in the SI, EYR and the ELR for the years studied. The changes indicate a dramatic movement away from sustainability towards an economy that places a significant load on its surrounding environment, as well as on the environmental space and ecological resources of other nations appropriated through trade.

The Ecological Footprint (EF) (Wackernagel & Rees, 1996) is a popular concept and accounting tool used to quantify the amount of resources consumed by a human population within a given area (Wackernagel, et al., 1999; Folke et al., 1997). With EF accounting, the resources consumed by a population are translated into an estimation of the amount of productive land needed to produce the resources in question. While the EF has some conceptual incongruities, primarily related to the translation of all resource flows into land-area (van den Bergh and Verbruggen, 1999), the strong spatial component of the EF makes it a powerful pedagogical tool and communicator of the indirect effects of resource consumption to end-users (Hannon, 1999). An energy-based ecological footprint can be calculated using data compiled for energy analyses. After all resource flows to a system have been accounted for and translated into energy values one can calculate an Energy Footprint Ratio (EFR). This is derived by dividing the total energy used by a system (U) by the total renewable energy flows (R) supporting that same system. The resulting number indicates how many times larger an economy's support area receiving renewable energy would have to be for it to meet its energy requirements locally. Figure 4.12 depicts this concept graphically.

As the ratios and indices show, the 1936 Danish economy is more indicative of a sustainable pattern of humans and nature on a national scale. With a fairly high EYR and a smaller ecological footprint, the 1936 Danish economy was able to function on a higher percentage of

locally available resources than in later years, and was more closely nested to the ecological systems and resources indigenous to Denmark. This fact is reflected in the kind of work the citizenry of Denmark were engaged in during this time. Moreover, the occupational diversity of modern Denmark is equally indicative of the less sustainable pattern exhibited by the economy in later years.

*Table 4.14. Sustainability indices for the Danish economy.*

	1936	1970	1999	Percent change	
				1936 to 1970	1970 to 1999
Emergy Yield Ratio (EYR)	1.90	1.21	1.56	-36%	28%
Environmental Load Ratio (ELR)	1.18	5.23	10.76	345%	106%
Sustainability Index (SI)	1.62	0.23	0.14	-86%	-37%
Emergy Footprint Ratio (EFR), (U/R)	2.18	6.23	11.76	187%	89%

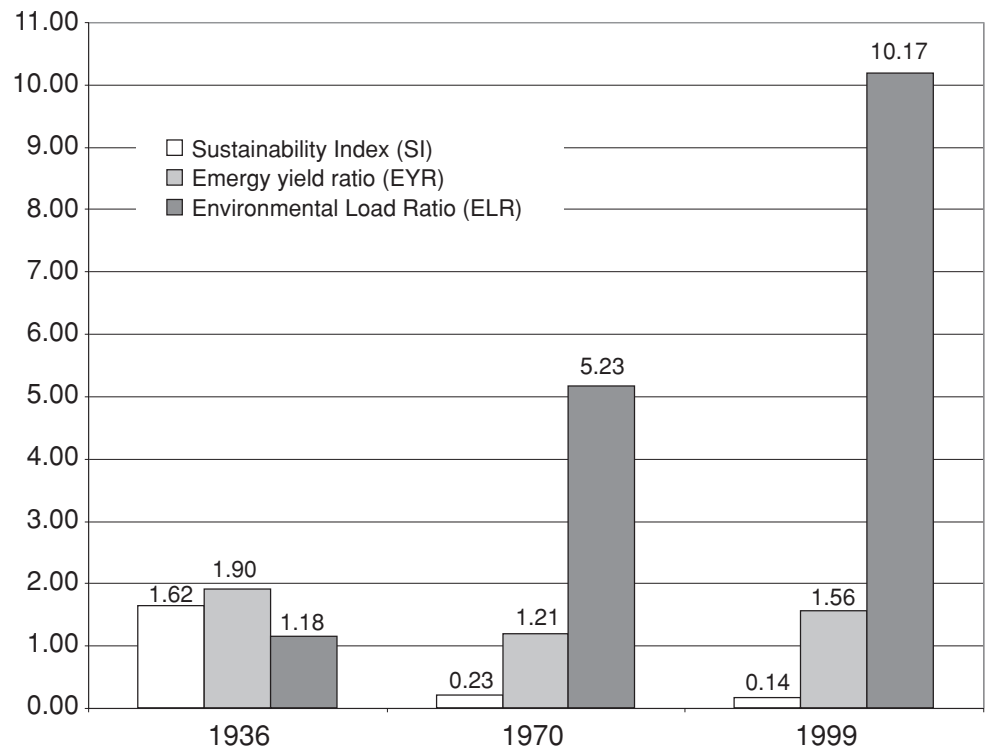

Figure 4.11. Graph showing a comparison of the Sustainability Index (SI), the Energy Yield Ratio (EYR) and the Environmental Load Ratio (ELR) for the Danish economy 1936, 1970 and 1999.

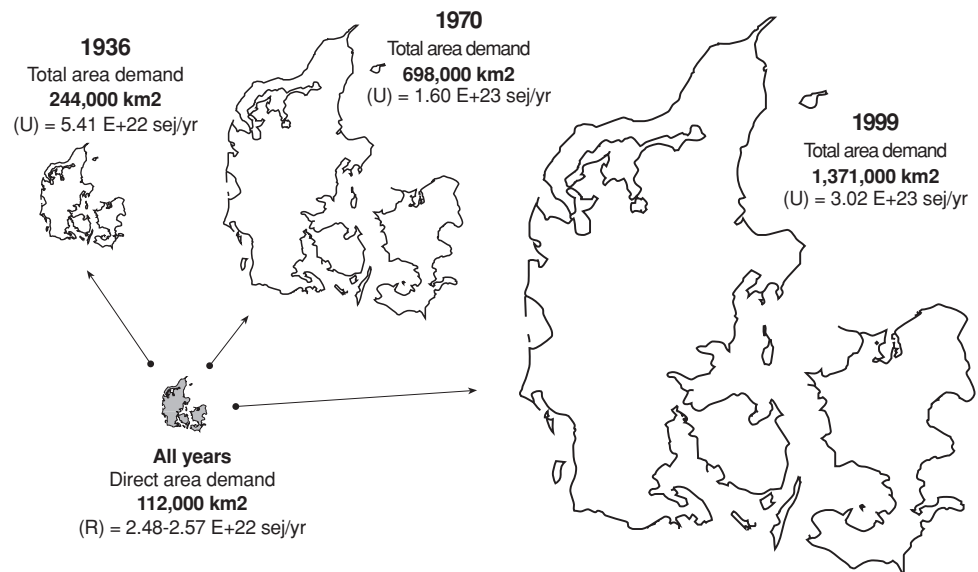

Figure 4.12. Denmark's expanding ecological footprint. The actual area of Denmark receiving renewable energy was unchanged at 112,000 km<sup>2</sup> for all the years studied. The total area demand, or energy footprint, of Denmark represents the total area that would be needed if the total energy use (U) of each year were to be met using only local, renewable sources (R).

### 4.3.3 Occupational Diversification - the Emergy Basis for a Service Economy in Denmark

The increase in emergy use by Denmark, and the resultant economic growth, has been attended by a movement away from agriculture as a major employment sector towards the public and private services sectors. This shift has paralleled the total increase in imports, exports and overall resource use. Figure 4.13 shows the breakdown of employment by economic sectors over the period studied. The agriculture, fishing, and forestry employment sectors have steadily shrunk from 1936 as the economy was mechanized, modernized and evolved to rely on more imported and non-renewable emergy. The manufacturing and construction sector, however, has remained a significant part of the employment structure of Denmark over the period studied. In accordance with emergy theory, service sector jobs reside in the higher tiers of the hierarchy of societal energy transformations. Thus, the shift to service jobs in Denmark on a nation-wide basis - many within high technology industries - was possible only because there were significant energy resources available to automate and mechanize the primary industries and rural sector, which form the basis of the material needs of society. This is a trend that is common in the modern industrialized nations of North America and Europe (Pimentel, 1989; Ulgiati et al, 1994; Sachs et al., 1998).

### 4.3.4 Danish Agriculture - the Limits of Productivity and Efficiency

Danish agriculture has witnessed equally dramatic changes over the period studied. When viewed through the lens of the Maximum Empower Principle (MEP), which stipulates that all systems are under evolutionary pressure to reach an optimum efficiency to maximize useful energy processing, the evaluations of Danish agriculture make for an interesting case study. The evaluations of Danish agriculture reveal a marked change in the total efficiency, in emergy terms, of Danish agricultural productivity over the three periods studied. Emergy theory and the MEP start with the assumption that all long run, well-tested

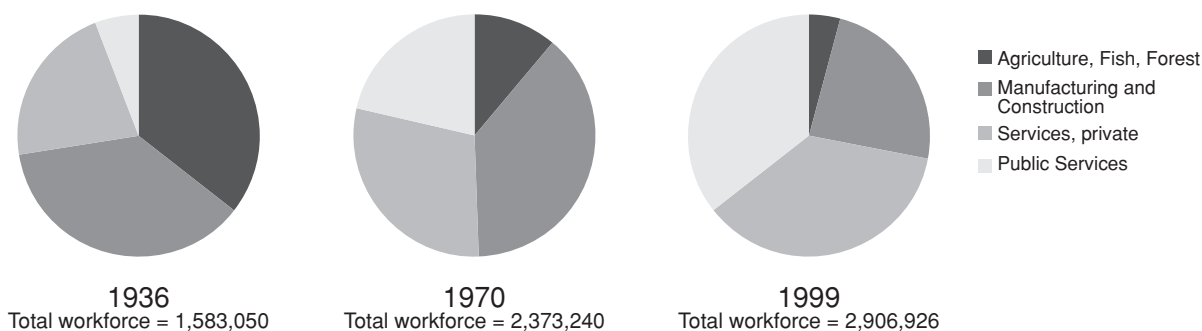

Figure 4.13. The shift in Denmark's employment structure out of the rural sector into manufacturing, construction and public and private services. Total number of employed people is shown below each chart (Statistics Denmark, 1937, 1972, 1999a).



systems are operating at or near their maximum thermodynamic efficiency, or are in a process of system-level learning towards this end. From this perspective, it is quite possible that the productivity of modern Danish agriculture has reached a limit set by the 2nd Law of Thermodynamics as it pertains to ecological-economic systems. A combined reading of the transformity, emergy signature and sustainability indices of Danish agricultural production elucidates this.

#### **4.3.5 The Transformity of Danish Agricultural Production**

At the system-level, transformity can give an aggregate measure of the energy transformation efficiency of a production process, quantifying the total Second Law losses necessary to make a product. As Odum states:

"The transformity that accompanies optimum efficiency for maximum power transfer has a theoretical lower limit that open systems may approach after a long period of self-organization. We can look for the empower transformations with the best efficiencies in systems that have been in environmental and economic competition for a long time." (Odum, 1996: 17-18)

Table 4.15 shows the transformities of the products of the Danish agricultural system by crop and livestock products. The change in the transformity indicates a loss of efficiency between 1936 and 1970, with significant efficiency gains between 1970 and 1999. The transformity of crop production was lowest in 1936 at 2.88 E+04 sej/J and highest in 1970 at 4.99 E+04 sej/J. In 1999, crop production had an intermediate transformity of 3.40 E+04 sej/J. In terms of livestock products, a transformity of 2.59 E+05 sej/J was calculated for 1999 and was the lowest of the three years. At first glance this increased efficiency may be construed as positive. However, when combined with an understanding of the common practices of animal husbandry in Denmark - which are centered around large-scale pork, poultry and dairy operations - this figure may indeed be too low. The transformity of livestock products for 1936 and 1970, when there were more mixed farms in operation (Statistics Denmark, 1937, 1971a) and more space per animal, may be as low as can be expected for animals to maintain a balanced existence.

*Table 4.15. The transformities of Danish crop and livestock production.*

	<b>1936</b>	<b>1970</b>	<b>1999</b>
Crops	2.88E+04 sej/J	4.99E+04 sej/J	3.40E+04 sej/J
Livestock	4.08E+05 sej/J	4.32E+05 sej/J	2.59E+05 sej/J

#### **4.3.6 Land Use and Structural Changes**

The changing energy signature of Danish agriculture has manifested itself in numerous land use and structural changes. One key change has been the areal extent of the agricultural system, and average farm size. While the total land in agricultural production decreased by approximately 19% from 1936 to 1999 (3,250,000 hectares to 2,644,000), the average farm size grew substantially, increasing from 15.5 ha/farm in 1936, to 21.0 ha/farm in 1970 and 45.7 ha/farm in 1999 (Statistics Denmark, 1937, 1972, 1999b). More telling still is the distribution of cultivated land according to farm size. Figure 4.14 presents pie charts of the distribution of cultivated land by farm size for each of the years studied. The pattern observed is one where large farms are increasingly responsible for a majority of agricultural production in Denmark.

#### **4.3.7 The Energy Signature of Danish Agriculture**

While providing an overview of conversion efficiency, taken alone, the transformity of a product does not provide enough information from which to draw conclusions regarding ecological sustainability. When combined with an explanation of the energy signature of a product (Campbell, 2000), and energy-based sustainability ratios (Ulgiati & Brown, 1998), transformities can provide an overview of the efficiency of a production process that includes a more complete consideration of the ecological-economic context of that process. Table 4.16 presents the energy signature of Danish agriculture over the years studied. Figure 4.15 presents the same data in graphic form.

In 1936, agriculture relied primarily on draught animals for traction and employed a large human workforce. This workforce was coupled to an economy that was supported by much less energy in comparison to later years. Thus, the labor of each person employed was of lower transformity. Consequently, the total energy contribution of human service in 1936 was less than in later years, even though more than twice as many people were directly engaged in agriculture. Moreover, in 1936, the supplemental energy sources applied to agricultural production were limited, while in 1999 the magnitude of the applied supplemental energies was quite large. This supplanted the human workforce to a large degree. Furthermore, in 1999, each person employed in agriculture was embedded in an economy in which the magnitude of energy support per person was much greater than previous years. Therefore, the total energy contribution of human services in this year was greater than 1936, even with only 22% of the workforce. In 1970, Danish agriculture was both highly mechanized in comparison to 1936, and employed a relatively large labor force when compared to 1999. Therefore, Danish agriculture in 1970 exhibited less efficiency than either 1936 or 1999, and placed a larger load on the environment. Ultimately, the pattern that Danish agriculture exhibited in 1970 was less sustainable than 1936 or 1999 as shown by the energy-based indicators presented subsequently.

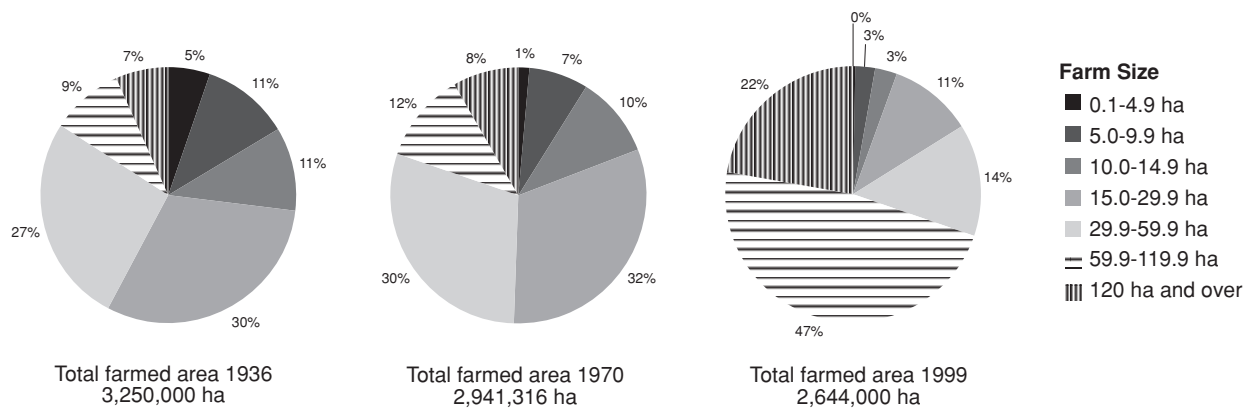

Figure 4.14. The distribution of cultivated land by size of farm for 1936, 1970 and 1999 (from Statistics Denmark, 1937, 1972 and 1999b).

Table 4.16. Changes in the energy signature of Danish agriculture.

Item	Energy flow (E+20 sej/yr)			Percent change	
	1936	1970	1999	1936 to 1970	1970 to 1999
Local renewable sources (R)	17.86	18.86	18.47	5	-1
Local non-renewable sources (N)	0.48	0.89	2.36	86	164
Applied energy (P)	2.72	12.12	28.50	345	135
Farm assets (P)	8.60	16.40	11.85	91	-28
Goods for crop production (P)	13.20	22.69	15.03	72	-34
Goods for livestock production (P)	20.06	15.25	20.11	-24	32
Services and labor (S)	89.41	170.82	108.42	91	-37

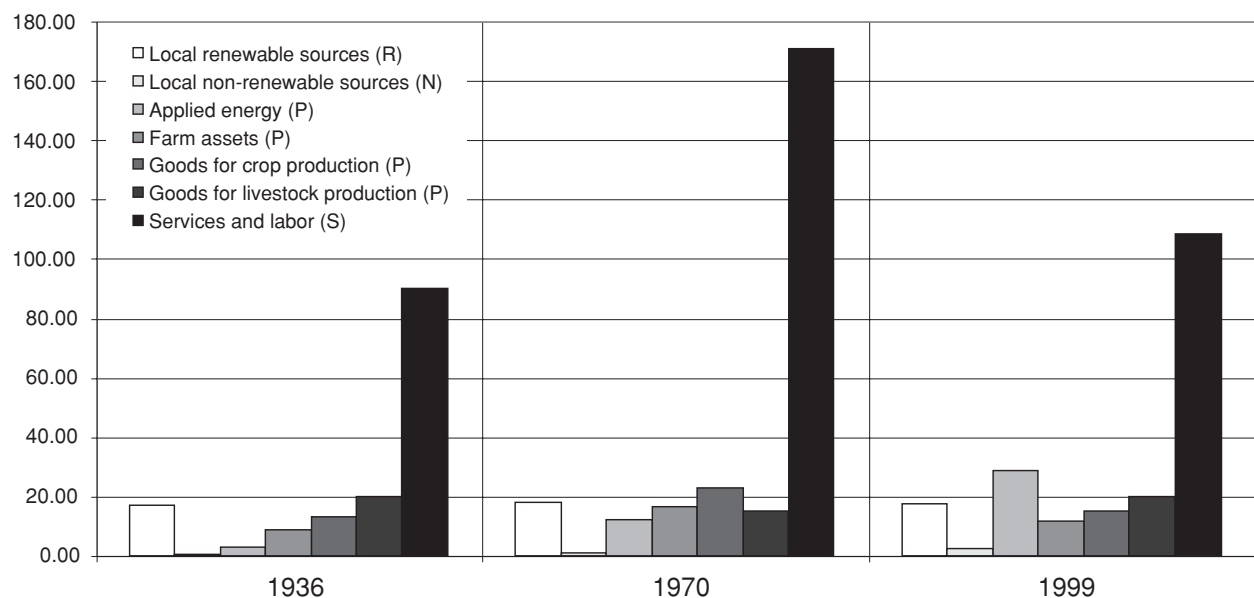

Figure 4.15. The energy signature of Danish agriculture 1936, 1970, 1999. Data E+20 sej/yr.

#### **4.3.8 Emergy-Based Sustainability Indices of Danish Agriculture**

The emergy-based indices and ratios calculated for this study indicate that Danish agriculture, as practiced in 1936, was the most sustainable of the years studied. With an EYR of 1.14, agriculture in 1936 made a greater net contribution to the national economy than later years. Furthermore, with a lower reliance on non-renewable emergy and purchased resources, the ELR was significantly lower than later years and this resulted in a SI that was higher than both 1970 or 1999, at 0.15. As stated above, the transformity of Danish agricultural production in 1936 was similar to or lower than later years, indicating that the system was well tested, and performing more optimally within its ecological and socioeconomic context. Table 4.17 present emergy indices for Danish agriculture.

The analysis of 1970 indicates an agricultural system that utilized large amounts of both high transformity labor and mechanical equipment, and therefore registered a high ELR. Furthermore, with low EYR and SI figures, and a higher transformity than either 1936 or 1999, Danish agriculture was not making as large a contribution to the surrounding economy as in 1936, and was a less efficient system overall than either 1936 or 1999. From the perspective of the Maximum Empower Principle, Danish agriculture in 1970 was in transition between two distinct types of farming systems and emergy signatures, and was not operating at maximum power.

In 1999, Danish agriculture exhibited signs of increased efficiency with low transformities for both crops and livestock, as well as a lower ELR and a higher EYR and SI than in 1970. However, the ELR was higher, and the EYR and SI lower than 1936. This indicates that, while not as sustainable as the horse-powered agricultural system of 1936, the agricultural system of 1999 had evolved in the direction of thermodynamic optimality in its modern context, with more supplemental energy coupled to more efficient machines allowing for a greater overall yield with the available emergy sources. So while 1999 represents an improvement over 1970, its reliance on large flows of non-renewable emergy is not a sustainable trajectory in the long run. Figure 4.16 presents a graph of the emergy-based sustainability indicators for the years studied.

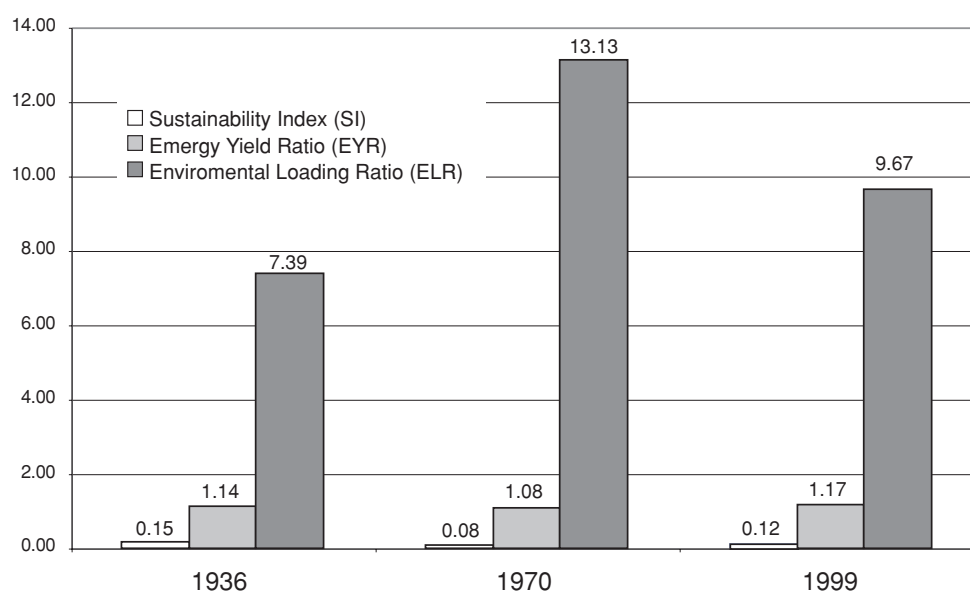

Figure 4.16. Graph of the SI, the EYR and the ELR for Danish agriculture for 1936, 1970 and 1999.

Table 4.17. Energy indices for Danish agriculture.

Name of Index	Expression	1936	1970	1999
Total Emergy (Y)	R+N+F	1.50E+22 sej	2.64E+22 sej	1.97E+22 sej
Emergy Investment Ratio	(P + S)/(N + R)	7.18	12.48	5.91
Nonrenewable/Renewable	(N + P)/R	2.39	3.98	3.80
Empower Density	sej/ha/yr	5.67E+15	8.97E+15	7.45E+15
Emergy Yield Ratio (EYR)	Y/P	1.14	1.08	1.17
Environmental Loading Ratio (ELR)	(P+N+S)/R	7.39	13.13	9.67
Sustainability Index (SI)	EYR/ELR	0.15	0.08	0.12

# 5 DISCUSSION AND CONCLUDING REMARKS

As coupled systems, the economy of Denmark and the Danish agricultural system have co-evolved. The analysis indicates that the greatest change has been a dramatic increase in total energy use by the economy as a whole. As expected, when the magnitude of the energy flowing through the Danish economy increased, the agricultural subsystem of Denmark registered distinct changes. Specifically, there were large increases in machinery and fossil energy employed in agriculture and a corresponding decrease in direct human labor requirements. What is interesting to note, however, is that the total amount of work supporting Danish agriculture, measured in energy, remained remarkably constant. The analysis indicates that it was primarily the distribution of work throughout the energy signature that changed. Using an ecological economic approach and presenting examples from U.S and Indian agriculture, Cleveland (1994) articulated a corollary to this process, and described it as a substitution of manufactured and natural capital for human and cultural capital. An explanation for the relative constancy of the total empower supporting Danish agriculture is that because agricultural systems are coupled to biological systems that have essentially fixed rates of energy processing and biomass accumulation that are limited by the photosynthetic process (Odum, 1994a; Straskraba et al., 1999), the thermodynamically optimal level of energy investment to agricultural production from society will remain fairly constant. Building on this insight, the analysis draws attention to the fact that the magnitude of non-agricultural economic activity that agricultural systems can power is limited. Figure 5.1 depicts this graphically.

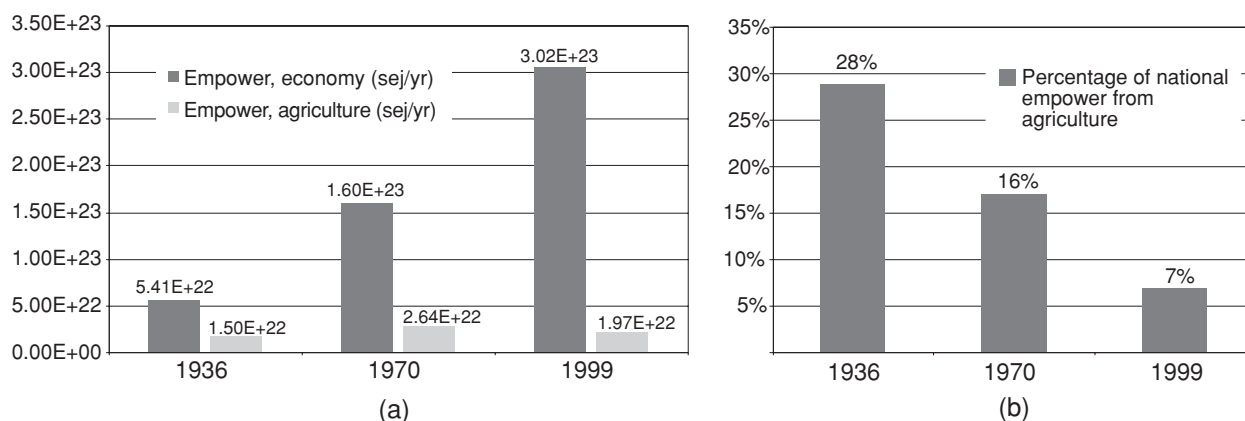

Figure 5.1. a) A comparison of the total empower of the Danish economy and agricultural subsystem for each of the years studied. b) The percentage of national empower derived from agricultural activities for each of the years studied.

## **5.1 The Distribution of Structural Complexity in Denmark**

As the industrial revolution progressed in Denmark, and as the Danish economy received a greater overall flux of matter and energy across its boundary, new societal structures and structural complexity were amassed differently throughout Denmark. Denmark has developed occupational diversity, and has expanded the parameters of the national energy hierarchy upwards, allowing for the development of high levels of service sector employment. Service sector jobs are primarily urban in character and the expansion of this sector mirrors an overall urbanization trend in Denmark over the period studied. Moreover, urban systems have relatively few pathways open to directly channel local renewable energy (Bolund & Hunhammar, 1999), instead, they build order primarily through the dissipation of imported energy flows. In Denmark, urban areas - cities, as well as large and small towns - are where the great majority of new societal structure was amassed over the twentieth century. The countryside, on the other hand, has seen a relative simplification (Kristensen, 1999; Porter & Petersen, 1997).

The shift in societal complexity from rural to urban areas parallels Denmark's transition from an agricultural society, primarily organized around flow limited renewable energy flows, to a modern industrial society primarily organized around flows from non-renewable storages. Schneider and Kay (1994) posit that evolving ecosystems develop in such a manner that they build more and more capacity to degrade incoming available energy and use that energy to build increasingly complex structures that enhance the ability of the ecosystem to ingest and degrade more energy. Odum (1994a) proposes that this pattern is a general one observed in both ecological and societal systems. Indeed, in many respects, this pattern is an accurate characterization of the growth of the Danish economy over the past century.

## **5.2 The Agricultural Treadmill and Reorganization for Maximum Empower**

The nation-wide adoption of new farm technology can be seen as an emergent property of the interactions between social goals, scientific/technological advancement and the level of energy available to the ecological-economic system within which an agricultural system is nested. The analysis indicates that direct fossil energy inputs, its derivatives in the form of chemical fertilizers and pesticides, as well as electricity (mainly from coal, natural gas, oil) were the main driving forces behind the development of Denmark's highly industrialized agricultural system (see also Schroll, 1994). While it is tempting to look for causal relationships, complex systems such as ecosystems and economic systems defy explanation in terms of linear causality. Implying nonlinearity, the metaphor of the agricultural treadmill (Cochrane, 1993) provides insight into the processes that evolve to entrain a certain level of resource use in production systems. As individual farmers adopt

successively more advanced technologies that are more efficient at utilizing available energy sources, they can produce a given product at a lower economic cost and thus out-compete their fellow farmers by undercutting them in competitive commodities markets. This process sets a new level of minimum efficiency that must be met for the average farmer to remain in production. Those farmers that cannot meet this standard often seek employment in other sectors and sell or lease out their land to those who remain in agricultural production. This process occurred in Denmark over the period studied (Ingemann, 1999).

Because most non-renewable energy sources fueling industrial economies have high net energy yields, and are not valued in monetary terms at a level commensurate with their energy contribution (Odum, 1996), they are often cheaply available. Farmers that organize their operations to draw on high yield energy sources are able to displace their fellow farmers who continue to organize their farming systems around local renewable energy flows - a process observed in Denmark as a fairly rapid shift from horse-powered farming to fully mechanized farming. As stated by Odum (1994a, p. 519): "As greater energies become available through trade for fuels or for goods and services based on fuels, agriculture becomes based increasingly on inputs from sales of crops and less on the environmental energies of sun, wind, rain and soil. Cash crops begin to replace diverse farms." This was the observed trend in Denmark.

Alfred Lotka (1922a,b) offered a thermodynamic interpretation of Darwinian natural selection that posits competition for available energy as a selection pressure constraining the development of natural systems - restated by Odum as the Maximum Empower Principle (Odum, 1996). Buenstorf (2000) indicates that the Lotka-Odum principle opens two viable strategies for competing organisms: efficiency and innovative specialization. Further, Buenstorf states: "organisms are favored which can utilize forms of energy flows for which no competition exists because other species are not capable of exploiting them" and that "selection favors organisms which can use contested energy flows more efficiently than their competitors for the preservation of the species." If we assume the metaphor of farm as organism, there is evidence that the two strategies of competing organisms - efficiency and innovative specialization - describes the survival strategies of modern farms quite well. Djurfeldt and Waldenstrom (1999) in their research on survival strategies of Swedish farm households identify three basic strategies: pluriactivity (the development of multiple income streams), intensification of production, or the adoption of new technology. A parallel process seems to have occurred in Denmark (Ingemann, 1999; Porter & Petersen, 1997).

In Denmark, the farms which mechanized first and thus were able to exploit energy forms for which no competition yet existed out-competed



their horse-farming counterparts, and ultimately displaced them. When all Danish farmers were using roughly equivalent technology, then the efficiency selection principle became operative - i.e. the efficient use of contested energy flows became a factor in the ongoing survival of the species (the farmer). As this process unfolded, those farmers who were displaced from agriculture and who subsequently relocated to urban areas often took jobs in the energy intensive manufacturing and service sectors. These jobs reside higher in the energy transformation hierarchy of society (Odum, 1996), and thus require larger emergy support for each job held. This reorganization process resulted in increased emergy use by the Danish economy as a whole. In sum, the mechanization of Danish agriculture and the shift in employment towards the urban sector was a reorganization for maximum empower on a national scale.

### **5.3 Concluding Remarks**

Although the processes of industrialization in Denmark have evolved through the utilization of fossil energy with little disruption, this will eventually change as world petroleum production is predicted by some to peak soon (Duncan & Youngquist, 1998; Deffeyes, 2001). After the production peak, petroleum output will decline and, eventually, the amount of energy needed to retrieve petroleum from the ground will outpace the amount of energy in the petroleum recovered. At that point, petroleum can no longer be considered an energy source, it will instead be an energy sink (Hall et al., 1986), not yielding enough net emergy to drive economic processes. Well before oil production becomes an energy sink, however, there will likely be a cascade of energy crises that will result in a dramatic increase in world oil prices (Rubin & Buchanan, 2000).

Along with the geopolitical considerations of the coming oil production peak and subsequent production decline and price increase, systemic oil dependence must be addressed in relation to human life support (Odum & Odum, 2001; Günther, 2000). If emergy flow is equated with the natural resource base that humans need to live, and more than half of a nation's emergy support is derived from non-renewable fuels, then the organizational pattern exhibited by that nation must be considered to be unsustainable in the long term. While Denmark is preparing more than almost any industrialized nation for the eventual decline in availability of cheap fossil fuel (Ostergaard, 1996; Morthorst, 1998), as the analysis shows, the current prosperity of the Danish economy is largely based on the emergy available from these rich fuels. Moreover, the analysis indicates that the degree to which agricultural production can substitute for these fuels is extremely limited.

In closing, agricultural systems cannot be a primary motive force in an economy with access to sources of cheap (large net emergy yield) fossil fuels. Nevertheless, agriculture is the primary means by which humans access the ecological systems they inhabit, and being that food is a

qualitatively unique resource, it will always be grown and will continue to be a source of biological and cultural sustenance for nations. A thriving agricultural sector, however, with a large proportion of a national population engaged in the growing of food, is only likely to come about when accessibility to sources of high net yield fossil energy is limited. At that time, agriculture, as the most time-tested means of capturing and channeling solar energy for societal use can once again be the primary domicile of a nation's economy and culture.



# REFERENCES

- Adams, R.N., 1988. *The Eighth Day. Social Evolution as the Self-Organization of Energy.* University of Texas Press, Austin.
- Appelqvist, L-Å. & R. Ohlson, 1972 (eds.) *Rapeseed: Cultivation, Composition, Processing and Utilization.* Elsevier, Amsterdam.
- Barkin, D. & Levins, R. 1998. *The Ecosocial Dynamics of Rural Systems,* In Rapport, D., Costanza, R., Epstein, P., Gaudet, C. & Levins, R. (Eds.) *Ecosystem Health.* Blackwell Science, Oxford.
- Barrett, G.W., 2001. *Closing the Ecological Cycle: The Emergence of Integrative Science.* *Ecosystem Health*, Vol., 7, No. 2, pp. 79-84.
- Björklund, J., 2000. *Emergy Analysis to Assess Ecological Sustainability: Strengths and weaknesses.* Dissertation, Agraria 242, Swedish University of Agricultural Sciences, Uppsala-Ultuna.
- Björklund, J., Limburg, K.E., & Rydberg, T., 1999. *Impact of production intensity on the ability of the agricultural landscape to generate ecosystem services: an example from Sweden.* *Ecological Economics* 29, pp. 269-291.
- Bolund, P. & Hunhammar, S., 1999. *Ecosystem services in urban areas.* *Ecological Economics* 29, pp. 293-301.
- Borgström-Hansson, C. & Wackernagel, M., 1999. *Rediscovering place and accounting space: how to re-embed the human economy.* *Ecological Economics* 29, pp. 203-213.
- Brandt-Williams, S.L., 2001. *Handbook of Emergy Evaluation: Folio #4.* Center for Environmental Policy. Environmental Engineering Sciences, University of Florida, Gainesville.
- Brown, M.T. & Arding, J., 1991. *Transformities*, working paper. Center for Wetlands, University of Florida.
- Brown, M.T. & Herendeen, R.A., 1996. *Embodied energy analysis and EMERGY analysis: a comparative view.* *Ecological Economics* 19, pp. 219-235.
- Brown, M.T. & Ulgiati, S., 1997. *Emergy-based indices and ratios to evaluate sustainability: monitoring economies and technology toward environmentally sound innovation.* *Ecological Engineering* 9, pp. 51-69.
- Brown, M.T. & Ulgiati, S., 1999. *Emergy Evaluation of the Biosphere and Natural Capital.* *Ambio* 28, vol. 6, pp.486-493.
- Brown, M.T., Woithe, R.D., Odum, H.T., Montague C.L. & Odum, E.C., 1993. *Emergy Analysis Perspectives on the Exxon Valdez Oil Spill in Prince William Sound, Alaska.* Report to the Cousteau Society. Center for Wetlands and Water Resources, Univ. of Florida, Gainesville. 122 pp.
- Buenstorf, G., 2000. *Self-organization and sustainability: energetics of evolution and implications for ecological economics.* *Ecological Economics* 33, pp. 119-134.
- Campbell, D., 2000. *Using Energy Systems Theory To Define, Measure, and Interpret Ecological Integrity and Ecosystem Health.* *Ecosystem Health*, Vol. 6, No. 3, pp. 181-204.

- Capra, F., 1996. *The Web of Life: a New Scientific Understanding of Living Systems*. Anchor Books. London.
- Cleveland, C., 1994. Re-allocating work between human and natural capital in agriculture: examples from India and the United States. In: Jansson, A-M., Folke, C., Costanza, R. (Eds.), *Investing in Natural Capital*. Island Press, Covelo, CA.
- Cochrane, W.W., 1993. *The Development of American Agriculture: A Historical Analysis*. University of Minnesota Press, Minneapolis.
- Conforti, P. & Giampietro, M., 1997. Fossil energy use in agriculture: an international comparison. *Agriculture, Ecosystems and Environment* 65, pp. 231-243.
- Conway, G., 1997. *The Doubly Green Revolution: Food for all in the Twenty-first Century*. Penguin, London.
- Costanza, R., 1980. Embodied Energy and Economic Evaluation. *Science* 210, pp. 1219-1224.
- Costanza, R., 2000. Social Goals and the Valuation of Ecosystem Services. *Ecosystems* 3, pp. 4-10
- Daily, G.C., 1997. *Nature's Services: Societal Dependence on Natural Ecosystems*. Island Press, Washington, D.C.
- Deffeyes, K.S., 2001. *Hubbert's Peak*. Princeton University Press. Princeton.
- Djurfeldt, G. & Waldenström, C., 1999. Mobility Patterns of Swedish Farming Households. *Journal of Rural Studies*, Vol.15, No.3, pp. 331-344.
- Doherty, S. & Rydberg, T. (eds.), 2002. *Ecosystem Properties and Principles of Living Systems as Foundation for Sustainable Agriculture*. *Ecological Agriculture* 32. Centre for Sustainable Agriculture. Swedish University of Agricultural Sciences, Uppsala.
- Doherty, S., Rydberg, T. & Salomonsson, L. 2000. *Ecosystem Properties and Principles of Living Systems for Sustainable Agriculture*. In: *Proceeding of the 13th International Scientific Conference of the International Federation of Organic Agriculture Movements (IFOAM)*, Basel, Switzerland, 28-31 August, 2000.
- Doherty, S.J., Nilsson, P.O., and Odum, H.T., 1993. *Emergy analysis of forest production and industries in Sweden*. Report to Vattenfall (Swedish Energy Board) and the Royal Swedish Academy of Agriculture and Forestry. Swedish Univ. Agricultural Sciences.
- Duke., J.A., 1983. *Handbook of Energy Crops*. Available on the internet at the following address; [http://www.hort.purdue.edu/newcrop/duke\\_energy/dukeindex.html](http://www.hort.purdue.edu/newcrop/duke_energy/dukeindex.html).
- Duncan, R.C., & Youngquist, W., 1998. *The World Petroleum Life-Cycle*. Paper Presented at Petroleum Technology Transfer Council Workshop: OPEC Oil Pricing and Independent Oil Producers, University of Southern California, Los Angeles.
- Ekman, M., 1993. Postglacial rebound and sea level phenomena, with special reference to Fennoscandia and the Baltic Sea. In: Kakkuri, J. (ed.) *Geodesy and geophysics*. Lecture notes for NKG-autumn school 1992 organized by Nordiska kommissionen for geodesi.

- Faber, M., Manstetten, R. & Proops, J.L.R., 1995. On the conceptual foundations of ecological economics: a teleological approach. *Ecological Economics* 12, pp. 41-54.
- FAO, 2002. The Food and Agriculture Organization of the United Nations. Website: [www.fao.org](http://www.fao.org).
- Folke, C., Berkes, F. & Colding, J., 1998. Ecological practices and social mechanisms for building resilience and sustainability. In Berkes, F., Folke, C. (Eds.) *Linking Social and Ecological Systems: Management practices and social mechanisms for building resilience*. Cambridge University Press, Cambridge.
- Folke, C., Jansson, Å. Larsson, J. & Costanza, R., 1997. Ecosystem Appropriation by Cities. *Ambio* Vol., 26, No. 3.
- Folke, C., Pritchard Jr, L., Berkes, F., Colding, J., Svedin, U., 1997. The problem of the fit between ecosystems and institutions. Bonn, Germany, International Human Dimensions Programme on Global Environment Change (IHDP).
- Francis, F.J. (ed.), 2000. *Wiley encyclopedia of food science and technology*. 2nd ed. John Wiley & Sons, Inc., New York.
- Fricke, A., 1998. Measuring up to sustainability. *Futures*, Vol. 30, No. 4, pp. 367-375.
- Funtowicz, S. & Ravetz, J., 1994. The worth of a songbird: ecological economics as a post-normal science. *Ecological Economics* 10, pp. 197-207.
- Giampietro, M. & Mayumi, K., 2000. Multiple-Scale Integrated Assessment of Societal Metabolism: Introducing the Approach. *Population and Environment*, Vol. 2, No. 22, pp. 109-153.
- Goldemberg, J., 1992. Energy, Technology and Development. *Ambio* 21, pp. 14-17.
- Gunderson, L., 2000. Ecological Resilience - In Theory and Practice. *Annual Review of Ecology and Systematics* 41, pp. 425-39.
- Günther, F. & Folke, C., 1993. Characteristics of Nested Living Systems. *Biological Systems*, 1 (3), pp. 257-274.
- Günther, F., 2000. Vulnerability in Agriculture: Energy Use, Structure and Energy Futures. Paper presented at the INES conference. June 15th 2000. Stockholm.
- Hall, C.A.S. (ed.), 1995. *Maximum Power: The Ideas and Applications of H.T. Odum*. Univ. Press of Colorado, Niwot, Colorado.
- Hansen, A. & Nielsen, J.D., 1995. Runoff and loss of soil and nutrients. In *Surface runoff, erosion and loss of phosphorus at two agricultural soils in Denmark. Plot studies 1989-92*. SP Report No.14. Danish Institute of Plant and Soil Science.
- Holland, B. et al (eds.), 1993. *McCance & Widdowson - The Composition of Foods*. 5th edition. The Royal Society of Chemistry and Ministry of Agriculture, Fisheries and Food, Cambridge.
- Holling, C.S. & Meeffe, G.K., 1996. Command and Control and the Pathology of Natural Resource Management. *Conservation Biology* Vol. 10 No. 2, pp. 328-337.
- Holling, C.S., 1998. Two Cultures of Ecology. *Conservation Ecology* 2(2):4

Available from the internet. URL: <http://www.consecol.org/vol2/iss2/art4>.

- Holling, C.S., 2001. Understanding the Complexity of Economic, Ecological, and Social Systems. *Ecosystems* 4, pp. 390-405.
- Holling, C.S., Berkes, F. & Folke, C., 1998. Science, sustainability and resource management. In Berkes, F., Folke, C. (Eds.) *Linking Social and Ecological Systems: Management practices and social mechanisms for building resilience*. Cambridge University Press, Cambridge.
- Ingemann, J.H., 1999. *The Political Economy of Satiety and Sustainability: evolutionary experience from Danish agriculture*. Working Paper from the Department of Economics, Politics and Public Administration. Aalborg University, Denmark.
- Jackson, W., 2002. Natural systems agriculture: a truly radical alternative. *Agriculture, Ecosystems and Environment* 88, pp. 111-117.
- Jansson, A-M. & Jansson, B-O. 1994. Ecosystem Properties as a Basis for Sustainability. In: Jansson, A-M., Folke, C., Costanza, R. (Eds.), *Investing in Natural Capital*. Island Press, Covelo, CA.
- Jantsch, E., 1980. *The Self-Organizing Universe: Scientific and Human Implications of the Emerging Paradigm of Evolution*. Pergamon Press, Oxford.
- Jørgensen, S.E., 1992. Exergy and Ecology. *Ecological Modelling*, 63, pp. 185-214.
- Jørgensen, S.E., Patten, B.C. & Straskraba, M., 1999. Ecosystems emerging 3: Openness. *Ecological Modelling* 117, pp. 41-64.
- Kampp, A.H., 1969. Denmark. In: *World Atlas of Agriculture: under the aegis of the International Association of Agricultural Economists*. Volume 1: Europe, U.S.S.R., Asia Minor. Novara: Ist. Geogr. De Agostini.
- Kay, J.J. & Schneider, E.D., 1994. Embracing Complexity: the Challenge of the Ecosystem Approach. *Alternatives*, Vol. 20, No.3, pp. 32- 38.
- Kay, J.J., 2000. Ecosystems as Self-organizing Holarthic Open Systems: Narratives and the Second Law of Thermodynamics. In Jørgensen, S.E., Müller, F., (Eds.) *Handbook of Ecosystems Theories and Management*. Lewis Publishers. London.
- Kay, J.J., Regier, H.A., Boyle, M. & Francis, G., 1999. An ecosystem approach for sustainability: addressing the challenge of complexity. *Futures* 31, pp. 721-742.
- Koestler, A., 1978. *Janus: A Summing Up*. Hutchinson, London.
- Kristensen, S.P., 1999. Agricultural land use and landscape changes in Rostrup, Denmark: processes of intensification and extensification. *Landscape and Urban Planning* 46, pp. 117-123.
- Lagerberg, C. & Brown, M.T., 1999. Improving Agricultural Sustainability: The Case of Swedish Greenhouse Tomatoes. *The Journal of Cleaner Production* 7, pp. 421-434.
- Lagerberg, C., Doherty, S.J. & Nilsson, P.O., 1999. Evaluation of the resource efficiency and sustainability of the Swedish economy using emergy-based indices. In *Dissertation, Agraria 191*, Swedish

University of Agricultural Sciences, Uppsala-Ultuna.

- Levin, S.A., 1999. *Fragile Dominion*. Perseus Publishing. Cambridge, Massachusetts.
- Levin, S.A., 2000. Ecosystems and the Biosphere as Complex Adaptive Systems. *Ecosystems* 1, pp. 431-436.
- Lewan, L., 1998. Why human societies need sustainability analyses based on biophysical assessments. *Ecological Economics* 29, pp. 57-60.
- Lotka, A.J., 1922a. Contribution to the energetics of evolution. *Proceedings of the National Academy of Sciences*, 8, pp. 147-151.
- Lotka, A.J., 1922b. Natural selection as a physical principle. *Proceedings of the National Academy of Sciences*, 8, pp. 151-154.
- Madison, M.G., 1997. 'Potatoes Made of Oil': Eugene and Howard Odum and the Origins and Limits of American Agroecology. *Environment and History*, 3, pp. 209-38.
- Mayumi, K., 1991. Temporary emancipation from land: from the industrial revolution to the present time. *Ecological Economics* 4, pp. 35-56.
- Meadows, D.H., Meadows, D.L., Randers, J. & Behrens, W.W. III, 1972. *The Limits to Growth: a Report for the Club of Rome's Project on the Predicament of Mankind*. Universe Books, New York.
- Mitchell, B.R., 1998. *International Historical Statistics: Europe 1750-1993*. Stockton Press, New York.
- Morthorst, P.E., 1998. The Cost of Reducing CO<sub>2</sub> Emissions-Methodological Approach, Illustrated by the Danish Energy Plan. *Biomass and Bioenergy* Vol. 15, No. 4/5, pp. 325-331.
- Müller, F. & Nielsen, S.N., 2000. Ecosystems as Subjects of Self-Organising Processes. In Jørgensen, S.E., Müller, F., (eds.) *Handbook of Ecosystems Theories and Management*. Lewis Publishers, London.
- Nicolis G. & Prigogine, I., 1977. *Self-Organization in Nonequilibrium Systems: From Dissipative Structures to Order through Fluctuations*. John Wiley & Sons, New York.
- Nielsen, S.N., 2000. Thermodynamics of an ecosystem interpreted as a hierarchy of embedded systems. *Ecological Modelling* 135, pp. 279-289.
- ODAL Maskin AB, 1990. *Kraftsamling*.
- Odum, H.T. & E.C. Odum, 1983. Energy analysis overview of nations. Working papers WP-83-82 of the International Institute for Applied Systems Analysis, A-2361 Laxenburg, Austria. 366 pp.
- Odum, H.T. & Odum, E.C., 1976. *The Energy Basis for Man and Nature*. McGraw-Hill, New York.
- Odum, H.T. & Odum, E.C., 2001. *A Prosperous Way Down: Principles and Policies*. University of Colorado Press, Boulder.
- Odum, H.T. & Odum, E.P., 2000. The Energetic Basis for the Valuation of Ecosystem Services. *Ecosystems* 3, pp. 21-23.
- Odum, H.T. & Pinkerton, R.C., 1955. Time's speed regulator: the optimum efficiency for maximum power output in physical and biological systems. *Am. Sci.* 43, 331-343.
- Odum, H.T., 1971. *Environment, Power and Society*. John Wiley & Sons



- Inc, New York.
- Odum, H.T., 1973. Energy, Ecology and Economics. *Ambio* vol. 2, no. 6. pp. 220-227.
- Odum, H.T., 1987. Living with Complexity. pp. 19-85 in Crafoord Prize in the Biosciences, 1987, Crafoord Lectures, Royal Swedish Academy of Science, Stockholm.
- Odum, H.T., 1988. Self-Organization, Transformity, and Information. *Science*, 242, pp. 1132-1139.
- Odum, H.T., 1989. Ecological engineering and self-organization. In: Mitsch, W. J. & Jørgensen, S.E. (Eds.), *Ecological Engineering: An Introduction to Ecotechnology*. John Wiley & Sons, New York.
- Odum, H.T., 1994a. *Ecological and General Systems: An Introduction to Systems Ecology*. University of Colorado Press, Boulder.
- Odum, H.T., 1994b. The emergy of natural capital. In: Jansson, A-M., Folke, C., Costanza, R. (Eds.), *Investing in Natural Capital*. Island Press, Covelo, CA.
- Odum, H.T., 1995. Self-Organization and Maximum Empower. In: C.A.S. Hall (Eds.) *Maximum Power: The Ideas and Applications of H.T. Odum*. Univ. Press of Colorado, Niwot, Colorado.
- Odum, H.T., 1996. *Environmental Accounting: EMERGY and Environmental Decision Making*. John Wiley & Sons, New York.
- Odum, H.T., Brown, M.T. & Ulgiati, S., 2000. Ecosystems as Energetic Systems. In Jørgensen, S.E., Müller, F., (eds.) *Handbook of Ecosystems Theories and Management*. Lewis Publishers. London.
- Ostergaard, I., 1996. *Renewable Energy in Denmark*. Renewable Energy Information Centre, Danish Technological Institute.
- Peterson, G. Allen, C.R. & Holling, C.S., 1998. Ecological Resilience, Biodiversity, and Scale. *Ecosystems* 1, pp. 6-18.
- Pimentel, D. & Pimentel, M., 1979. *Food, Energy and Society*. John Wiley & Sons, New York.
- Pimentel, D., 1989. Agriculture and Ecotechnology. In Mitsch, J. & Jørgensen, S.E. (Eds.) *Ecological Engineering: An Introduction to Ecological Engineering*. John Wiley & Sons, New York.
- Porter, J.R. & Petersen, E.H., 1997. Danish Agriculture and its Sustainability: A Profile. *Ambio*, Vol. 26, No. 7.
- Pretty, J., 1998. *The Living Land*. Earthscan, London.
- Ravetz, J. & Funtowicz, S., 1999. Post-Normal Science - and insight now maturing. *Futures* 31, pp. 641-646.
- Rees, W., 1998. How should a parasite value its host?. *Ecological Economics* 25, pp. 49-52.
- Röling, 1988. *Extension science: Information systems in agricultural development*. Cambridge: Cambridge University Press.
- Röling, N., 1997. The soft side of land: socio-economic sustainability of land use systems. *ITC Journal*, 3/4, pp. 248-262.
- Rubin, J. & Buchanan, P., 2000. *Why Oil Prices Will Have To Go Higher*. CIBC World Markets, Occasional Report #28, February, 2000.
- Rydberg, T., & Jansen, J., 2002. Horsepower-emergy support for local feed and fossil fuelled traction in agriculture. In Jansen, J.,

- Agriculture, Energy and Sustainability. Dissertation, Agraria 253, Swedish University of Agricultural Sciences, Uppsala-Ultuna.
- Sachs, W., Loske, R. & Linz, M., 1998. Greening the North: A Post-Industrial Blueprint for Ecology and Equity. New York: Zed Books.
- Schjønning, P., 1995. Erodibility Index of Danish Soils. In Surface runoff, erosion and loss of phosphorus at two agricultural soils in Denmark. Plot studies 1989-92. SP Report No.14. Danish Institute of Plant and Soil Science.
- Schneider, E.D. & Kay, J.J., 1994, Life as a Manifestation of the Second Law of Thermodynamics. Mathematical and Computer Modelling, Vol. 19, No. 6-8, pp. 25-48.
- Schroll, H., 1994. Energy-flow and ecological sustainability in Danish Agriculture. Agriculture, Ecosystems and Environment 52, pp. 301-310.
- Sibbesen, E., 1995. Phosphorus, nitrogen, and carbon in particle-size fractions of soils and sediments. In: Surface runoff, erosion and loss of phosphorus at two agricultural soils in Denmark. Plot studies 1989-92. SP Report No.14. Danish Institute of Plan
- Statistics Denmark, 1937. Statistical Yearbook. Copenhagen, Denmark.
- Statistics Denmark, 1968a. Agricultural Statistics 1900-1965. Volume I: Agricultural Area and Harvest and Use of Fertilizers. Copenhagen, Denmark.
- Statistics Denmark, 1968b. Agricultural Statistics 1900-1965. Volume II: Livestock and Livestock Products and Consumption of Feeding Stuffs. Copenhagen, Denmark.
- Statistics Denmark, 1971a. Statistical Yearbook. Copenhagen, Denmark.
- Statistics Denmark, 1971b. Statistics on agriculture, gardening and forestry. Copenhagen, Denmark.
- Statistics Denmark, 1999a. Statistical Yearbook. Copenhagen, Denmark.
- Statistics Denmark, 1999b. Agricultural Statistics. Copenhagen, Denmark.
- Statistics Denmark, 1999c. External Trade of Denmark. Copenhagen, Denmark.
- Statistics Denmark, 2001. Statistical Yearbook. Copenhagen, Denmark.
- Straskraba, M., Jørgensen, S.E., & Patten, B.C., 1999. Ecosystems emerging 2: Dissipation. Ecological Engineering 117, pp. 3-39.
- Sveriges Nationalatlas, 1994.
- Tacconi, L., 1998. Scientific methodology for ecological economics. Ecological Economics 27, pp. 91-105.
- The Royal Danish Geographic Institute, 1986. Landbrugsatlas Danmark (Agricultural Atlas of Denmark)
- Tsoumis, G., 1991. Science and Technology of Wood. Structure, Properties, Utilization. Van Nostrand Reinhold, New York.
- Ulgiati, S. & Brown, M.T., 1998. Monitoring patterns of sustainability in natural and man-made ecosystems. Ecological Modelling 108, pp. 23-36.
- Ulgiati, S., Odum, H.T., & Bastioni, S., 1994. Emergy use, environmental loading and sustainability: an emergy analysis of Italy. Ecological

- Modelling 73, pp. 215-268.
- United States Department of Energy, Energy Information Administration, 2001.
- Wackernagel, M. & Rees, W., 1996. *Our Ecological Footprint: Reducing Human Impact on the Earth*. Gabriola Island, B.C.: New Society Publishers.
- Waltner-Toews, D. & Wall, E., 1997. Emergent perplexity: In Search of Post-normal Questions for Community and Agroecosystem Health. *Social Science and Medicine*, Vol. 45, No. 11, pp. 1741-1749.
- World Commission on Environment and Development (WCED), 1987. *Our Common Future*. Oxford University Press, Oxford.
- World Resources Institute (WRI), 1994. *World Resources, 1994-95*, Oxford University Press, Oxford.
- World Resources Institute (WRI), 2000. *A Guide to World Resources 2000-2001: People and Ecosystems, The Fraying Web of Life*. WRI, Washington, D.C.
- Zucchetto, J. & Jansson, A-M., 1985. *Resources and Society: A Systems Ecology Study of the Island of Gotland, Sweden*. Springer-Verlag, New York.

# ACKNOWLEDGEMENTS

If there is one thing that emergy analysis and systems thinking helps you to realize it is that we all exist in a network of support, and this work would not have been possible without the support of many people. Firstly, I would like to acknowledge the support of my family. Especially, I would like to thank my grandfather Robert L. Cooper for his assistance and encouragement of my studies, without whom my journey to Sweden and Denmark, and this thesis, would not have been possible. I would also like to thank my grandfather William C. Haden. His excitement over the prospects of my studying in Sweden, at a time when I was contemplating whether to come over or not, was a strong impetus for me to pursue this Masters degree. My immediate family; my mother Judith Haden, my father Dennis Haden and my brother Christian Haden, who are also my close friends, have been very supportive of me during my necessary time away from home. To my wonderful friend and partner Johanna Hök, I would like to say thank you for your love, support and patience.

In terms of intellectual support, the people who contributed to this work are numerous. First and foremost, I want to thank my main supervisor Torbjörn Rydberg, of the Department of Ecology and Crop Production Science (EVP) and the Center for Sustainable Agriculture (CUL), for his genuine interest in my work and for his constant encouragement, patience and generosity with his time. Our lively discussions about emergy, systems ecology, agriculture and the state of the world provided the inspiration that helped me through some of the intellectual roadblocks that I encountered during my research. Lennart Salomonsson of the Department of Rural Development Studies (DRDS) and CUL, introduced me to the emergy concept and provided me with constant encouragement, initial direction and the key literature that got me interested in using emergy analysis in my thesis. Petra Vergunst from the DRDS provided me with much constructive guidance and encouragement as my work evolved. Our discussions helped clarify for me the strengths and limitations of biophysical perspectives on rural development and agricultural sustainability. I would like to thank my fellow MADRAT students, the DRDS faculty and staff, and especially Elizabeth Dressie, for welcoming me to Sweden and arranging many of my important personal affairs in advance of my arrival, may she rest in peace.

In Denmark, I would like to thank the administration and staff of The Folkecenter for Renewable Energy (FC), where I lived for four months during the summer of 2001. Particularly, I would like to thank the Folkecenter trainees: Istvan, Juan, Soto and Malik, with whom I had many enjoyable moments while at FC. I would also like to thank Jan Holm Ingemann, Chris Kjeldsen and Pia Johansen of Aalborg University who graciously hosted me during my visit to Aalborg. Also in Denmark, I

would like to thank the folks at the Svanholm Collective and the people working on the Danish Eco-experimental zones outside of Aalborg, for showing me around and sharing their ideas with me. Finally, I would like to thank all those researchers and activists who have sought to understand the causes of, and striven to find solutions for, the ecological crises we now face. It is through their perseverance in establishing innovative modes of inquiry that the groundwork for this thesis was laid. Together, as planetary citizens, we will uncover solutions to the interconnected problems facing humanity in the 21st century.

# APPENDIX A – REFERENCES FOR TRANSFORMITIES

- A Odum, 1996. Environmental Accounting: Emergy and Environmental Decision Making. John Wiley & Sons, New York.
- B Brown, M.T. & Arding, J., 1991. Transformities, working paper. Center for Wetlands, University of Florida.
- C Lagerberg, C., Doherty, S.J., & Nilsson, P.O., 1999. Evaluation of the resource efficiency and sustainability of the Swedish economy using emergy-based indices. Doctoral Dissertation. SLU
- D Odum, H.T. & E.C. Odum, 1983. Emergy analysis overview of nations. Working papers WP-83-82 of the International Institute for Applied Systems Analysis, A-2361 Laxenburg, Austria. 366 pp.
- E Doherty, S.J., Nilsson, P.O., & Odum, H.T., 1993. Emergy analysis of forest production and industries in Sweden. Report to Vattenfall (Swedish Energy Board) and the Royal Swedish Academy of Agriculture and Forestry. Swedish Univ. Agricultural Sciences,
- F Ulgiati et al., 1994. Emergy use, environmental loading and sustainability. An emergy analysis of Italy. Environmental Modelling 73: 215-268.
- G This study.
- G\* This study. Transformity calculated according to the fractions of the primary flows for this category.
- H Brown, M.T., Woithe, R.D., Odum, H.T., Montague C.L. & Odum, E.C., 1993. Emergy Analysis Perspectives on the Exxon Valdez Oil Spill in Prince William Sound, Alaska. Report to the Cousteau Society. Center for Wetlands and Water Resources, Univ. of Florida, Gainesville. 122 pp.

# APPENDIX B – FOOTNOTES TO EMERGY CALCULATIONS

The codes listed in the import and export sections refer to the trade category codes used in the Danish statistical abstracts.

## Footnotes to Table 4.2, emergy analysis of Denmark, 1936.

### RENEWABLE RESOURCES:

- 1 SOLAR ENERGY: Total area receiving solar input =  $1.12\text{E}+11 \text{ m}^2$ . Continental shelf area =  $6.86\text{E}+10 \text{ m}^2$  at 200 m depth (WRI, 1994), Land area =  $4.31\text{E}+10 \text{ m}^2$  (Statistics Denmark, 1999). Insolation =  $3.70\text{E}+03 \text{ MJ/m}^2/\text{yr}$  (Mean value; The Royal Danish Geographic Institute, 1986). Albedo = 0.20 [% given as decimal]. Solar energy received,  $J = 1.12\text{E}+11 [\text{m}^2, \text{ area incl. shelf}] \times 3.70\text{E}+03 [\text{MJ/m}^2/\text{yr}, \text{ avg. insolation}] \times (1-0.20) [1-\text{albedo}] \times 1\text{E}6 [\text{J/MJ}] = 3.31\text{E}+20 \text{ J/yr}$
- 2 WIND ENERGY: Surface wind is 60% of the wind speed at 1000 m; i.e. 40% of the wind speed is absorbed. Average wind speed at ground = 7.0 m/s (\* estimate from Statistics Denmark, 1971a, 1937) Energy =  $1000 [\text{m}, \text{ height of boundary layer}] \times 1.23 [\text{kg/m}^3, \text{ density of air}] \times 43100000000 [\text{m}^2, \text{ area}] \times (0.4 [40\%] \times 7.0 [\text{m/s}, \text{ wind speed}] / 0.6 [60\% \text{ of wind speed absorbed at ground}])^2 / 2 = 5.77\text{E}+14 \text{ J/yr}$
- 3 RAIN, CHEMICAL POTENTIAL ENERGY: Cont. Shelf Area =  $6.86\text{E}+10 \text{ m}^2$  at 200 m depth (WRI, 1994), Land area =  $4.31\text{E}+10 \text{ m}^2$  (Statistics Denmark, 1971a). Precipitation rate, 1936 = 0.66 m/yr (Statistics Denmark, 1937). Evapotranspiration rate = 0.35 m/yr (47% of rainfall \* estimate from Lagerberg et al. 1999). Energy (land),  $J = 4.31\text{E}+10 [\text{m}^2, \text{ area}] \times 0.66 [\text{m/yr}, \text{ rainfall}] \times 0.47 [\text{evapotranspiration}] \times 1000 [\text{kg/m}^3] \times 4.94\text{E}+03 [\text{J/kg Gibbs no.}] = 7.68\text{E}+16 \text{ J/yr}$ . Energy (shelf),  $J = 6.86\text{E}+10 [\text{m}^2, \text{ area}] \times 0.76 [\text{m/yr}, \text{ rainfall}] \times 1000 [\text{kg/m}^3] \times 4.94\text{E}+03 [\text{J/kg Gibbs no.}] = 2.61\text{E}+17 \text{ J/yr}$ . Total energy,  $J = 2.90\text{E}+17 \text{ J/yr}$
- 4 RAIN, GEOPOTENTIAL ENERGY: Energy,  $J = 4.31\text{E}+10 [\text{m}^2 \text{ land area}, (\text{Statistics Denmark}, 1937)] \times 0.39 [\% \text{ runoff rate, given as decimal}] \times 0.66 [\text{m/yr}, \text{ precipitation rate}, (\text{Statistics Denmark}, 1937)] \times 30 [\text{m}, \text{ mean elevation}] \times 1000 [\text{kg/m}^3, \text{ density of water}] \times 9.8 [\text{m/s}^2, \text{ gravity}] = 2.41\text{E}+15 \text{ J/yr}$
- 5 WAVE ENERGY: Length of shoreline = 3379000 m (WRI, 1994). Wave energy =  $3379000 [\text{m}, \text{ shore length}] \times 1/8 \times 1025 [\text{kg/m}^2, \text{ density}] \times 9.8 [\text{m/s}^2, \text{ gravity}] \times 0.5^2 [\text{m}, \text{ height squared}] \times (9.8 \times 6)^{1/2} [\text{m}, \text{ mean shoaling depth, from Lagerberg et al., 1999}] \times 31.54 \text{ E}6 [\text{sec/yr}] = 6.28\text{E}+17 \text{ J/yr}$
- 6 TIDAL ENERGY: 50% of tidal energy is assumed to be absorbed by shelf. Energy,  $J = 6.86\text{E}+10 [\text{m}^2, \text{ area of shelf}] \times 0.5 [50\%] \times 7.06\text{E}+02 [\text{tides/y}, \text{ estimation of 2 tides/day in 365 days}] \times 0.31^2 [\text{m}, \text{ mean}]$

tidal range<sup>2</sup>] x 1.01E+03 [kg/m<sup>3</sup>, density of seawater] x 9.8m/s<sup>2</sup>  
[gravity] = 2.29E+16 J/yr

7 EARTH CYCLE: Energy, J = 4.31E+10 [m<sup>2</sup>, land area] x 1.00E+06 [J/m<sup>2</sup>, heat flow, estimate from Odum, 1996] = 4.31E+16 J/yr

### **INDIGENOUS RENEWABLE ENERGY:**

8 AGRICULTURAL PRODUCTION: See agriculture analysis, 1937, for energy calculations. Energy, J = 0.0 J/yr (Statistics Denmark, 1968a)

9 LIVESTOCK PRODUCTION: See agriculture analysis, 1937, for energy calculations. Energy, J = 0.0 J/yr (Statistics Denmark, 1968b)

10 FOREST EXTRACTION: 2.05E+06 m<sup>3</sup> Harvest (Statistics Denmark, 1937). Energy, J = 2.05E+06 [m<sup>3</sup>] x 0.53E+06 [g/m<sup>3</sup>, density of wood, (Tsoumis, 1991)] x 0.8 [80% dry material, given as decimal] x 3.6 [Cal/g] x 4186 [J/Cal] = 1.31E+16 J/yr

### **NONRENEWABLE RESOURCE USE FROM WITHIN DENMARK:**

11 COKE: Consumption = 3.02E+05 Tn/yr (Mitchell, 1998). Energy, J = 3.02E+05 [Tn/yr] x 2.9E+10 [J/Tn] = 8.76E+15 J/yr

12 CALCIUM CARBONATE: Consumption = 3.87E+04 Tn/yr (Statistics Denmark, 1937). Mass(g) = 3.87E+04 [Tn/yr] x 1E6 [g/Tn] = 3.87E+10 g/yr

13 MINERALS: Production = 1.04E+06 Tn/yr (Statistics Denmark, 1937) Codes V,X. Mass (g) = 1.04E+06 [Tn/yr] x 1E6 [g/Tn] = 1.04E+12 g/yr

14 TOPSOIL: Energy, J = 6.51E+14 [J/yr, (Schjønning, 1995)] see 1936 agriculture analysis for energy calculations.

### **IMPORTS OF OUTSIDE ENERGY SOURCES:**

15 COAL: Imports = 5.84E+06 Tn/yr (Statistics Denmark, 1937), Code V: Coal, coke, and briquettes. Energy, J = 5.84E+06 [Tn/yr] x 3.18E10 [J/Tn] = 1.86E+17 J/yr

16 CRUDE OIL: Imports = 2.84E+05 Tn/yr (Statistics Denmark, 1937), Code N: Petroleum/Gasoline. Energy, J = 2.84E+05 [Tn/yr] x 7.3 [bbl/Tn] x 6.1 E9 [J/barrel] = 1.27E+16 J/yr

17 GAS/FUEL OIL: Imports = 2.84E+05 Tn/yr (Statistics Denmark, 1937), Code N, Fuel oil, duty-free. Energy, J = 7.61E+06 [Tn/yr] x 6.9 [bbl/Tn] x 5.83 E6 [Btu/bbl] x 1054 [J/Btu] = 3.23E+17 J/yr

18 OIL DERIVED PRODUCTS: Imports = 1.97E+05 Tn/yr (Statistics Denmark, 1937), Code N: lamp oil, lubric. oil, asphalt. Energy, J = 1.97E+05 [Tn/yr] x 6.4 [bbl/Tn] x 5.83 E6 [Btu/bbl] x 1054 [J/Btu] = 7.74E+15 J/yr

19 METALS: Imports = 5.49E+05 Tn/yr (Statistics Denmark, 1937), Codes; Y, Z. Mass (g) = 5.49E+05 [Tn/yr] x 1E+6 [g/Tn] = 5.49E+11 g/yr

20 MINERALS: Imports = 3.62E+05 Tn/yr (Statistics Denmark, 1937), Codes V,X. Mass (g) = 3.62E+05 [Tn/yr] x 1E+6 [g/Tn] = 3.62E+11 g/yr



- 21 FOOD and AGRICULTURAL PRODUCTS: Imports =  $2.21\text{E}+06$  Tn/yr (Statistics Denmark, 1937), Codes; C,D,E,F,G, some of N,R,T. Energy,  $J = 2.21\text{E}+06$  [Tn/yr]  $\times 1\text{E}+6$  [g/Tn]  $\times 3.5$  [Kcal/g]  $\times 4186$  [J/Kcal]  $\times 0.8$  [80% dry matter] =  $2.59\text{E}+16$  J/yr
- 22 LIVESTOCK, MEAT, FISH: Imports =  $7.95\text{E}+04$  Tn/yr (Statistics Denmark, 1937), Codes; A,B. Energy,  $J = 7.95\text{E}+04$  [Tn/yr]  $\times 1\text{E}+6$  [g/Tn]  $\times 5$  [Kcal/g]  $\times 4186$  [J/Kcal]  $\times 0.22$  [22% protein by weight] =  $3.66\text{E}+14$  J/yr
- 23 FISHERIES PRODUCTION: Fish Catch =  $8.70\text{E}+04$  Tn/yr, data for 1935 (Mitchell, 1998). Energy,  $J = 8.70\text{E}+04$  [Tn/yr]  $\times 1\text{E}+06$  [g/Tn]  $\times 5$  [Cal/g]  $\times 0.2$  [20% protein content by weight]  $\times 4186$  [J/Cal] =  $3.64\text{E}+14$  J/yr
- 24 PLASTICS & RUBBER: Imports =  $6.87\text{E}+03$  Tn/yr (Statistics Denmark, 1937), Codes; O, some of N. Mass (g) =  $6.87\text{E}+03$  [Tn/yr]  $\times 1\text{E}+6$  [g/Tn] =  $6.87\text{E}+09$  g/yr
- 25 CHEMICALS: Imports =  $5.80\text{E}+05$  Tn/yr (Statistics Denmark, 1937), Code U. Mass (g) =  $5.80\text{E}+05$  [Tn/yr]  $\times 1\text{E}+6$  [g/Tn] =  $5.80\text{E}+11$  g/yr
- 26 WOOD, PAPER, TEXTILES, LEATHER: Imports =  $7.43\text{E}+05$  Tn/yr (Statistics Denmark, 1937), [Mix of imports approx. 60% wood, 35% paper, 5%, leather and textiles] Codes H,I,J,K,L,M,P,Q,S. Energy,  $J = 7.43\text{E}+05$  [Tn/yr]  $\times 1\text{E}+6$  [g/Tn]  $\times 1.5\text{E}+4$  [J/g] =  $1.11\text{E}+16$  J/yr
- 27 MACHINERY, TRANSPORTATION, EQUIPMENT: Imports =  $2.92\text{E}+04$  Tn/yr (Statistics Denmark, 1937), Code Æ. Mass (g) =  $2.92\text{E}+04$  [Tn/yr]  $\times 1\text{E}+6$  [g/Tn] =  $2.92\text{E}+10$  g/yr
- 28 IMPORTED SERVICES: USD Dollar value =  $3.30\text{E}+08$  USD (Statistics Denmark, 1937) [Main trading partners, Germany, Sweden, UK, Netherlands, USA, Italy, France in terms of economic value.]

### **EXPORTS OF ENERGY, MATERIALS AND SERVICES:**

- 29 METALS: Exports =  $1.20\text{E}+05$  Tn/yr (Statistics Denmark, 1937), Codes; Y, Z. Mass (g) =  $1.20\text{E}+05$  [Tn/yr]  $\times 1\text{E}+6$  [g/Tn] =  $1.20\text{E}+11$  g/yr
- 30 MINERALS: Exports =  $6.14\text{E}+05$  Tn/yr (Statistics Denmark, 1937), Codes V,X. Mass (g) =  $6.14\text{E}+05$  [Tn/yr]  $\times 1\text{E}+6$  [g/Tn] =  $6.14\text{E}+11$  g/yr
- 31 FOOD and AGRICULTURAL PRODUCTS: Exports =  $3.81\text{E}+05$  Tn/yr (Statistics Denmark, 1937) Codes; C,D,E,F,G,R,T, some of N. Energy,  $J = 5.89\text{E}+06$  [Tn/yr]  $\times 1\text{E}+6$  [g/Tn]  $\times 3.5$  [Kcal/g]  $\times 4186$  [J/Kcal]  $\times 0.8$  [80% dry matter] =  $4.46\text{E}+15$  J/yr
- 32 LIVESTOCK, MEAT, FISH: Exports =  $5.64\text{E}+05$  Tn/yr (Statistics Denmark, 1937), Codes, 01,02,03,04,05. Energy,  $J = 5.64\text{E}+05$  [Tn/yr]  $\times 1\text{E}+6$  [g/Tn]  $\times 5$  [Kcal/g]  $\times 4186$  [J/Kcal]  $\times 0.22$  [22% protein by weight] =  $2.60\text{E}+15$  J/yr
- 33 WOOD, PAPER, TEXTILES, LEATHER: Exports =  $5.64\text{E}+04$  Tn/yr (Statistics Denmark, 1937), Codes H,I,J,K,L,M,P,Q,S. Energy,  $J = 5.64\text{E}+04$  [Tn/yr]  $\times 1\text{E}+6$  [g/Tn]  $\times 1.5\text{E}+4$  [J/g] =  $6.80\text{E}+14$  J/yr

- 34 CHEMICALS: Exports =  $9.76\text{E}+04$  Tn/yr (Statistics Denmark, 1937), Code U. Mass (g) =  $9.76\text{E}+04$  [Tn/yr]  $\times$   $1\text{E}+6$  [g/Tn] =  $9.76\text{E}+10$  g/yr
- 35 PLASTICS & RUBBER: Exports =  $3.43\text{E}+02$  Tn/yr (Statistics Denmark, 1937), Code; O. Mass (g) =  $3.43\text{E}+02$  [Tn/yr]  $\times$   $1\text{E}+6$  [g/Tn] =  $3.43\text{E}+08$  g/yr
- 36 MACHINERY, TRANSPORTATION, EQUIPMENT: Exports =  $2.71\text{E}+04$  Tn/yr (Statistics Denmark, 1937), Code AE. Mass (g) =  $2.71\text{E}+04$  [Tn/yr]  $\times$   $1\text{E}+6$  [g/Tn] =  $2.71\text{E}+10$  g/yr
- 37 SERVICES IN EXPORTS: USD Dollar Value =  $2.95\text{E}+08$  USD (Statistics Denmark, 1937)

## Footnotes to Table 4.4, emergy analysis of Denmark, 1970.

### RENEWABLE RESOURCES:

- 1 SOLAR ENERGY: Total area receiving solar input =  $1.12\text{E}+11$  m<sup>2</sup>. Continental shelf area =  $6.86\text{E}+10$  m<sup>2</sup> at 200 m depth (WRI, 1994), Land area =  $4.31\text{E}+10$  m<sup>2</sup> (Statistics Denmark, 1999). Insolation =  $3.70\text{E}+03$  MJ/m<sup>2</sup>/yr (Mean value; The Royal Danish Geographic Institute, 1986). Albedo = 0.20 [% given as decimal]. Solar energy received, J =  $1.12\text{E}+11$  [m<sup>2</sup>, area incl. shelf]  $\times$   $3.70\text{E}+03$  [MJ/m<sup>2</sup>/yr, avg. insolation]  $\times$  (1-0.20) [1-albedo]  $\times$   $1\text{E}6$  [J/MJ] =  $3.31\text{E}+20$  J/yr
- 2 WIND ENERGY: Surface wind is 60% of the wind speed at 1000m; i.e. 40% of the wind speed is absorbed. Average wind speed at ground = 7.0 m/s (Statistics Denmark, 1971a). Energy = 1000 [m, height of boundary layer]  $\times$  1.23 [kg/m<sup>3</sup>, density of air]  $\times$   $43100000000$  [m<sup>2</sup>, area]  $\times$  (0.4 [40%]  $\times$  7.0 [m/s, wind speed] / 0.6 [60% of wind speed absorbed at ground])<sup>2</sup> / 2 =  $5.77\text{E}+14$  J/yr
- 3 RAIN, CHEMICAL POTENTIAL ENERGY: Cont. Shelf Area =  $6.86\text{E}+10$  m<sup>2</sup> at 200 m depth (WRI, 1994), Land area =  $4.31\text{E}+10$  m<sup>2</sup> (Statistics Denmark, 1971a). Precipitation rate, 1999 = 0.76 m/yr (Statistics Denmark, 1971a). Evapotranspiration rate = 0.35 m/yr (47% of rainfall \* estimate from Lagerberg et al. 1999). Energy (land), J =  $4.31\text{E}+10$  [m<sup>2</sup>, area]  $\times$  0.76 [m/yr, rainfall]  $\times$  0.47 [evapotranspiration]  $\times$  1000 [kg/m<sup>3</sup>]  $\times$   $4.94\text{E}+03$  [J/kg Gibbs no.] =  $7.68\text{E}+16$  J/yr. Energy (shelf), J =  $6.86\text{E}+10$  [m<sup>2</sup>, area]  $\times$  0.76 [m/yr, rainfall]  $\times$  1000 [kg/m<sup>3</sup>]  $\times$   $4.94\text{E}+03$  [J/kg Gibbs no.] =  $2.61\text{E}+17$  J/yr. Total energy, J =  $3.34\text{E}+17$  J/yr
- 4 RAIN, GEOPOTENTIAL ENERGY: Energy, J =  $4.31\text{E}+10$  [m<sup>2</sup> land area, (Statistics Denmark, 1971a)]  $\times$  0.39 [% runoff rate, given as decimal]  $\times$  0.76 [m/yr, precipitation rate, (Statistics Denmark, 1971a)]  $\times$  30 [m, mean elevation]  $\times$  1000 [kg/m<sup>3</sup>, density of water]  $\times$  9.8 [m/s<sup>2</sup>, gravity] =  $3.67\text{E}+15$  J/yr
- 5 WAVE ENERGY: Length of shoreline = 3379000 m (WRI, 1994) Wave energy = 3379000 [m, shore length]  $\times$  1/8  $\times$  1025 [kg/m<sup>2</sup>, density]  $\times$  9.8 [m/s<sup>2</sup>, gravity]  $\times$  0.5<sup>2</sup> [m, height squared]  $\times$  (9.8  $\times$  6)<sup>1/2</sup> [m, mean shoaling depth, from Lagerberg et al., 1999]  $\times$   $31.54\text{E}6$

- [sec/yr] =  $6.28 \times 10^{17}$  J/yr
- 6 TIDAL ENERGY: 50% of tidal energy is assumed to be absorbed by shelf. Energy,  $J = 6.86 \times 10^{10}$  [m<sup>2</sup>, area of shelf]  $\times$  0.5 [50%]  $\times$   $7.06 \times 10^{02}$  [tides/y, estm. of 2 tides/day in 365 days]  $\times$   $0.31^2$  [m, mean tidal range<sup>2</sup>]  $\times$   $1.01 \times 10^3$  [kg/m<sup>3</sup>, density of seawater]  $\times$   $9.8 \text{ m/s}^2$  [gravity] =  $2.29 \times 10^{16}$  J/yr
- 7 EARTH CYCLE: Energy,  $J = 4.31 \times 10^{10}$  [m<sup>2</sup>, land area]  $\times$   $1.00 \times 10^6$  [J/m<sup>2</sup>, heat flow, estimate from Odum, 1996] =  $4.31 \times 10^{16}$  J/yr

### **INDIGENOUS RENEWABLE ENERGY:**

- 8 RENEWABLE ENERGY: Consumption =  $100000$  Tn/yr [mostly forestry waste] (Statistics Denmark, 1971a). Energy,  $J = 1 \times 10^5$  [Tn, forest waste]  $\times$   $1 \times 10^6$  [g/Tn]  $\times$  3.6 [Cal/g]  $\times$  4186 [J/Cal] =  $1.51 \times 10^{15}$  J/yr
- 9 AGRICULTURAL PRODUCTION: See agriculture analysis, 1971, for energy calculations. Energy,  $J = 0.0$  J/yr (Statistics Denmark, 1971b)
- 10 LIVESTOCK PRODUCTION: See agriculture analysis, 1970, for energy calculations. Energy,  $J = 0.0$  J/yr (Statistics Denmark, 1971b)
- 11 FOREST EXTRACTION:  $1.90 \times 10^6$  m<sup>3</sup> Harvest (Statistics Denmark, 1971b). Energy,  $J = 1.90 \times 10^6$  [m<sup>3</sup>]  $\times$   $0.53 \times 10^6$  [g/m<sup>3</sup>, density of wood, (Tsoumis, 1991)]  $\times$  0.8 [80% dry material, given as decimal]  $\times$  3.6 [Cal/g]  $\times$  4186 [J/Cal] =  $1.21 \times 10^{16}$  J/yr

### **NONRENEWABLE RESOURCE USE FROM WITHIN DENMARK:**

- 12 CRUDE OIL, production: Production =  $2.00 \times 10^5$  Tn (Statistics Denmark, 1971a). Energy,  $J = 2.00 \times 10^5$  [Tn]  $\times$  7.3 [bbl/Tn]  $\times$   $6.1 \times 10^9$  [J/bbl] =  $8.91 \times 10^{15}$  J/yr
- 13 COAL: Production =  $1.00 \times 10^5$  Tn/yr (Mitchell, 1998). Energy,  $J = 1.00 \times 10^5$  [Tn/yr]  $\times$   $2.9 \times 10^{10}$  [J/Tn] =  $2.90 \times 10^{15}$  J/yr
- 14 METALS: (Au,Ag,Pb,Cu,Zn,Fe,Mn,Mo), Production =  $5.41 \times 10^5$  Tn/yr (Statistics Denmark, 1971a). Mass(g) =  $5.41 \times 10^5$  [Tn/yr]  $\times$   $1 \times 10^6$  [g/MT] =  $5.41 \times 10^9$  g/yr
- 15 MINERALS: Production =  $2.28 \times 10^6$  Tn/yr Data from 1968 (Statistics Denmark, 1971a). Mass (g) =  $2.28 \times 10^6$  [Tn/yr]  $\times$   $1 \times 10^6$  [g/Tn] =  $2.28 \times 10^{12}$  g/yr
- 16 TOPSOIL: Energy,  $J = 1.21 \times 10^{15}$  [J/yr, (Schjønning, 1995)] see 1970 agriculture analysis for energy calculations

### **IMPORTS OF OUTSIDE ENERGY SOURCES:**

- 17 COAL: Imports =  $3.37 \times 10^6$  Tn/yr (Statistics Denmark, 1971a), Code 27.01.11-20. Energy,  $J = 3.37 \times 10^6$  [Tn/yr]  $\times$   $3.18 \times 10^{10}$  [J/Tn] =  $1.07 \times 10^{17}$  J/yr
- 18 CRUDE OIL: Imports =  $1.01 \times 10^7$  Tn/yr (Statistics Denmark, 1971a), Code 27.09. Energy,  $J = 1.01 \times 10^7$  [Tn/yr]  $\times$  7.3 [bbl/Tn]  $\times$   $6.1 \times 10^9$  [J/barrel] =  $4.51 \times 10^{17}$  J/yr

- 19 GAS/FUEL OIL: Imports =  $7.61E+06$  Tn/yr (Statistics Denmark, 1971a), Codes 27.51.2, 27.55.2. Energy, J =  $7.61E+06$  [Tn/yr]  $\times$  6.9 [bbl/Tn]  $\times$   $5.83 E6$  [Btu/bbl]  $\times$  1054 [J/Btu] =  $3.23E+17$  J/yr
- 20 OIL DERIVED PRODUCTS: Imports =  $3.57E+06$  Tn/yr (Statistics Denmark, 1971a), Code 27, all excluding 27.01.11-20, 27.09, 27.51.2, 27.55.2. Energy, J =  $3.57E+06$  [Tn/yr]  $\times$  6.4 [bbl/Tn]  $\times$   $5.83 E6$  [Btu/bbl]  $\times$  1054 [J/Btu] =  $1.40E+17$  J/yr
- 21 METALS: Imports =  $1.86E+06$  Tn/yr (Statistics Denmark, 1971a), Codes 73,74,75,76,77,78,79,80,81,82, 83. Mass (g) =  $1.86E+06$  [Tn/yr]  $\times$   $1E+6$  [g/Tn] =  $1.86E+12$  g/yr
- 22 MINERALS: Imports =  $2.43E+06$  Tn/yr (Statistics Denmark, 1971a), Codes 25,26,68. Mass (g) =  $2.43E+06$  [Tn/yr]  $\times$   $1E+6$  [g/Tn] =  $2.43E+12$  g/yr
- 23 FOOD and AGRICULTURAL PRODUCTS: Imports =  $2.43E+06$ Tn/yr (Statistics Denmark, 1971a), Codes 6,7,8,9,10,11,12,13,14,17,18, 19,20,21,22,23,24. Energy, J =  $2.43E+06$  [Tn/yr]  $\times$   $1E+6$  [g/Tn]  $\times$  3.5 [Kcal/g]  $\times$  4186 [J/Kcal]  $\times$  0.8 [80% dry matter] =  $2.84E+16$  J/yr
- 24 LIVESTOCK, MEAT, FISH: Imports =  $4.05E+05$  Tn/yr (Statistics Denmark, 1971a), Codes 2,3,4,5,15,16. Energy, J =  $4.05E+05$  [Tn/yr]  $\times$   $1E+6$  [g/Tn]  $\times$  5 [Kcal/g]  $\times$  4186 [J/Kcal]  $\times$  0.22 [22% protein by weight] =  $1.87E+15$  J/yr
- 25 FISHERIES PRODUCTION: Fish Catch =  $1.24E+06$  Tn/yr. Data for 1969 (Statistics Denmark, 1971a). Energy, J =  $1.24E+06$  [Tn/yr]  $\times$   $1E+06$  [g/Tn]  $\times$  5 [Cal/g]  $\times$  0.2 [20% protein content by weight]  $\times$  4186 [J/Cal] =  $5.19E+15$  J/yr
- 26 PLASTICS & RUBBER: Imports =  $3.33E+05$  Tn/yr (Statistics Denmark, 1971a), Codes 39, 40. Mass (g) =  $3.33E+05$  [Tn/yr]  $\times$   $1E+6$  [g/Tn] =  $3.33E+11$  g/yr
- 27 CHEMICALS: Imports =  $1.71E+06$  Tn/yr (Statistics Denmark, 1971a), Codes 28, 29, 30, 31, 32, 33, 34, 35, 36, 37, 38. Mass (g) =  $3.05E+06$  [Tn/yr]  $\times$   $1E+6$  [g/Tn] =  $1.71E+12$  g/yr
- 28 WOOD, PAPER, TEXTILES, LEATHER: Imports =  $1.96E+06$  Tn/yr (Statistics Denmark, 1971a), [Mix of imports approx. 60% wood, 35% paper, 5%, leather and textiles] Codes 41, 42, 43, 44, 45, 46, 47, 48, 49, 50, 51, 52, 53, 54, 55, 56, 57, 58, 59, 60, 61, 62, 63, 64, 65, 66, 67, 94. Energy, J =  $1.96E+06$  [Tn/yr]  $\times$   $1E+6$  [g/Tn]  $\times$   $1.5E+4$  [J/g] =  $2.94E+16$  J/yr
- 29 MACHINERY, TRANSPORTATION, EQUIPMENT: Imports =  $7.62E+05$  Tn/yr (Statistics Denmark, 1971a), Codes, 84, 85, 86, 87, 88, 89, 90, 91, 92, 93. Mass (g) =  $1.70E+06$  [Tn/yr]  $\times$   $1E+6$  [g/Tn] =  $7.62E+11$  g/yr
- 30 IMPORTED SERVICES: USD Dollar value =  $4.38E+09$ USD (Statistics Denmark, 1971a) [Main trading partners, Germany, Sweden, UK, Netherlands, USA, Italy, France in terms of economic value. Sej/\$ of trading partners (Switz, Japan, Spain, Netherland, W. Germ., USA) from Odum, 1996]
- 31 TOURISM : Dollar Value =  $2.60E+08$  USD (Statistics Denmark, 1971a)

## **EXPORTS OF ENERGY, MATERIALS AND SERVICES**

- 32 COAL: Exports =  $2.10E+01$  Tn/yr (Statistics Denmark, 1971a) Code 27.01.11-20. Energy,  $J = 2.10E+01$  [Tn/yr]  $\times 3.18E+10$  [J/Tn] =  $6.68E+11$  J/yr
- 33 CRUDE OIL: Exports =  $1.80E+01$  Tn/yr (Statistics Denmark, 1971a) Code 27.09. Energy,  $J = 1.80E+01$  [Tn]  $\times 7.3$  [bbl/Tn]  $\times 6.1E+09$  [J/bbl] =  $8.02E+11$
- 34 GAS/FUEL OIL: Exports =  $8.37E+05$  Tn/yr (Statistics Denmark, 1971a) Codes 27.51.2, 27.55.2. Energy,  $J = 8.37E+05$  [Tn]  $\times 6.4$  [bbl/Tn]  $\times 5.83 E6$  [Btu/barrel]  $\times 1054$  [J/Btu] =  $3.55E+16$  J/y
- 35 OIL DERIVED PRODUCTS: Exports =  $1.05E+06$  Tn/yr (Statistics Denmark, 1971a) Code 27, all excluding 27.01.11-20, 27.09, 27.51.2, 27.55.2. Energy,  $J = 1.05E+06$  [Tn]  $\times 6.4$  [bbl/Tn]  $\times 5.83 E6$  [Btu/barrel]  $\times 1054$  [J/Btu] =  $4.13E+16$  J/y
- 36 METALS: Exports =  $4.03E+05$  Tn/yr (Statistics Denmark, 1971a), Codes, 73, 74, 75, 76, 77, 78, 79, 80, 81, 82, 83. Mass (g) =  $4.03E+05$  [Tn/yr]  $\times 1E+6$  [g/Tn] =  $4.03E+11$  g/yr
- 37 MINERALS: Exports =  $3.97E+06$  Tn/yr (Statistics Denmark, 1971a), Codes, 25, 26, 68. Mass (g) =  $3.97E+06$  [Tn/yr]  $\times 1E+6$  [g/Tn] =  $3.97E+12$  g/yr
- 38 FOOD and AGRICULTURAL PRODUCTS: Exports =  $1.63E+06$  Tn/yr (Statistics Denmark, 1971a) Codes 06, 07, 08, 09, 10, 11, 12, 13, 14, 17, 18, 19, 20, 21, 22, 23, 24. Energy,  $J = 5.89E+06$  [Tn/yr]  $\times 1E+6$  [g/Tn]  $\times 3.5$  [Kcal/g]  $\times 4186$  [J/Kcal]  $\times 0.8$  [80% dry matter] =  $1.91E+16$  J/yr
- 39 LIVESTOCK, MEAT, FISH: Exports =  $1.48E+06$  Tn/yr (Statistics Denmark, 1971a), Codes, 01,02,03,04,05. Energy,  $J = 1.48E+06$  [Tn/yr]  $\times 1E+6$  [g/Tn]  $\times 5$  [Kcal/g]  $\times 4186$  [J/Kcal]  $\times 0.22$  [22% protein by weight] =  $6.80E+15$  J/yr
- 40 WOOD, PAPER, TEXTILES, LEATHER: Exports =  $8.35E+05$  Tn/yr (Statistics Denmark, 1971a), Codes 41, 42, 43, 44, 45, 46, 47, 48, 49, 50, 51, 52, 53, 54, 55, 56, 57, 58, 59, 60, 61, 62, 63, 64, 65, 66, 67, 94. Energy,  $J = 8.35E+05$  [Tn/yr]  $\times 1E+6$  [g/Tn]  $\times 1.5E+4$  [J/g] =  $1.01E+16$  J/yr
- 41 CHEMICALS: Exports =  $2.67E+05$  Tn/yr (Statistics Denmark, 1971a), Codes 28, 29, 30, 31, 32, 33, 34, 35, 36, 37, 38. Mass (g) =  $2.67E+05$  [Tn/yr]  $\times 1E+6$  [g/Tn] =  $2.67E+11$  g/yr
- 42 MACHINERY, TRANSPORTATION, EQUIPMENT: Exports =  $5.30E+05$  Tn/yr (Statistics Denmark, 1971a), Codes, 84, 85, 86, 87, 88, 89, 90, 91, 92, 93 Mass (g) =  $5.30E+05$  [Tn/yr]  $\times 1E+6$  [g/Tn] =  $5.30E+11$  g/yr
- 43 PLASTICS & RUBBER: Exports =  $7.98E+04$  Tn/yr (Statistics Denmark, 1971a), Codes 39, 40. Mass (g) =  $7.98E+04$  [Tn/yr]  $\times 1E+6$  [g/Tn] =  $7.98E+10$  g/yr
- 44 SERVICES IN EXPORTS: USD Dollar Value =  $3.29E+09$  USD (Statistics Denmark, 1971a)

## Footnotes to Table 4.6, emergy analysis of Denmark, 1999.

### RENEWABLE RESOURCES:

- 1 SOLAR ENERGY: Total area receiving solar input =  $1.12\text{E}+11$  m<sup>2</sup>.  
Continental shelf area =  $6.86\text{E}+10$  m<sup>2</sup> at 200 m depth (WRI, 1994),  
Land area =  $4.31\text{E}+10$  m<sup>2</sup> (Statistics Denmark, 1999). Insolation =  $3.70\text{E}+03$  MJ/m<sup>2</sup>/yr (Mean value; The Royal Danish Geographic Institute, 1986). Albedo = 0.20 [% given as decimal]. Solar energy received, J =  $1.12\text{E}+11$  [m<sup>2</sup>, area incl. shelf] x  $3.70\text{E}+03$  [MJ/m<sup>2</sup>/yr, avg. insolation] x (1-0.20) [1-albedo] x  $1\text{E}6$  [J/MJ] =  $3.31\text{E}+20$  J/yr
- 2 WIND ENERGY: Surface wind is 60% of the wind speed at 1000 m; i.e. 40% of the wind speed is absorbed. Average wind speed at ground = 7.6 m/s (\*Data for 1998, Statistics Denmark, 1999). Energy = 1000 [m, height of boundary layer] x 1.23 [kg/m<sup>3</sup>, density of air] x  $43100000000$  [m<sup>2</sup>, area] x (0.4 [40%] x 7.6 [m/s, wind speed] / 0.6 [60% of wind speed absorbed at ground])<sup>2</sup> / 2 =  $6.80\text{E}+14$  J/yr
- 3 RAIN, CHEMICAL POTENTIAL ENERGY: Cont. Shelf Area =  $6.86\text{E}+10$  m<sup>2</sup> at 200 m depth (WRI, 1994), Land area =  $4.31\text{E}+10$  m<sup>2</sup> (Statistics Denmark, 1999). Precipitation rate, 1999 = 0.77 m/yr (Statistics Denmark, 1999). Evapotranspiration rate = 0.35 m/yr (47% of rainfall \* estimate from Lagerberg et al. 1999). Energy (land), J =  $4.31\text{E}+10$  [m<sup>2</sup>, area] x 0.77 [m/yr, rainfall] x 0.47 [evapotranspiration] x 1000 [kg/m<sup>3</sup>] x  $4.94\text{E}+03$  [J/kg Gibbs no.] =  $7.68\text{E}+16$  J/yr. Energy (shelf), J =  $6.86\text{E}+10$  [m<sup>2</sup>, area] x 0.77 [m/yr, rainfall] x 1000 [kg/m<sup>3</sup>] x  $4.94\text{E}+03$  [J/kg Gibbs no.] =  $2.61\text{E}+17$  J/yr. Total energy, J =  $3.38\text{E}+17$  J/yr
- 4 RAIN, GEOPOTENTIAL ENERGY: Energy, J =  $4.31\text{E}+10$  [m<sup>2</sup> land area, (Statistics Denmark, 1999)] x 0.39 [% runoff rate, given as decimal] x 0.77 [m/yr, precipitation rate, (Statistics Denmark, 1999)] x 30 [m, mean elevation] x 1000 [kg/m<sup>3</sup>, density of water] x 9.8 [m/s<sup>2</sup>, gravity] =  $3.77\text{E}+15$  J/yr
- 5 WAVE ENERGY: Length of shoreline = 3379000 m (WRI, 1994). Wave energy = 3379000 [m, shore length] x 1/8 x 1025 [kg/m<sup>2</sup>, density] x 9.8 [m/s<sup>2</sup>, gravity] x 0.5<sup>2</sup> [m, height squared] x (9.8 x 6)<sup>1/2</sup> [m, mean shoaling depth, from Lagerberg et al., 1999] x  $31.54\text{E}6$  [sec/yr] =  $6.28\text{E}+17$  J/yr
- 6 TIDAL ENERGY: 50% of tidal energy is assumed to be absorbed by shelf. Energy, J =  $6.86\text{E}+10$  [m<sup>2</sup>, area of shelf] x 0.5 [50%] x  $7.06\text{E}+02$  [tides/y, estm. of 2 tides/day in 365 days] x 0.31<sup>2</sup> [m, mean tidal range<sup>2</sup>] x  $1.01\text{E}+03$  [kg/m<sup>3</sup>, density of seawater] x 9.8m/s<sup>2</sup> [gravity] =  $2.29\text{E}+16$  J/yr
- 7 EARTH CYCLE: Energy, J =  $4.31\text{E}+10$  [m<sup>2</sup>, land area] x  $1.00\text{E}+06$  [J/m<sup>2</sup>, heat flow, estimate from Odum, 1996] =  $4.31\text{E}+16$  J/yr

### INDIGENOUS RENEWABLE ENERGY:

- 8 RENEWABLE ENERGY: Energy, J =  $8.10\text{E}+16$  J/yr [Mostly straw, wind and waste combustion (Statistics Denmark, 2001)]

- 9 AGRICULTURAL PRODUCTION: See agriculture analysis, 1999, for energy calculations. Energy,  $J = 2.36E+17 \text{ J/yr}$  (Statistics Denmark, 1999b)
- 10 LIVESTOCK PRODUCTION: See agriculture analysis, 1999, for energy calculations. Energy,  $J = 4.56E+16 \text{ J/yr}$  (Statistics Denmark, 1999b)
- 11 FOREST EXTRACTION:  $1.72E+06 \text{ m}^3$  Harvest (Statistics Denmark, 1999b). Energy,  $J = 1.72E+06 \text{ [m}^3] \times 0.53E+06 \text{ [g/m}^3, \text{ density of wood, (Tsoumis, 1991)]} \times 0.8 \text{ [80\% dry material, given as decimal]} \times 3.6 \text{ [Cal/g]} \times 4186 \text{ [J/Cal]} = 1.10E+16 \text{ J/yr}$

### **NONRENEWABLE RESOURCE USE FROM WITHIN DENMARK:**

- 12 NATURAL GAS, production: Production =  $7.45E+09 \text{ m}^3/\text{yr}$ . 1997 figures (Statistics Denmark, 1999). Energy,  $J = 7.45E+09 \text{ [m}^3/\text{yr]} \times 35.31 \text{ [m}^3/\text{ft}^3] \times 1.055E+6 \text{ [J/ft}^3] = 2.78E+17 \text{ J/yr}$
- 13 NATURAL GAS, consumption: Consumption =  $4.16E+09 \text{ m}^3/\text{yr}$  \*1997 figures (Statistics Denmark, 1999). Energy,  $J = 4.16E+09 \text{ [m}^3/\text{yr]} \times 35.31 \text{ [m}^3/\text{ft}^3] \times 1.055E+6 \text{ [J/ft}^3] = 1.55E+17 \text{ J/yr}$
- 14 CRUDE OIL, production: Production =  $1.49E+07 \text{ Tn}$  (Statistics Denmark, 2001). Energy,  $J = 1.49E+07 \text{ [Tn]} \times 7.3 \text{ [bbl/Tn]} \times 6.1 \text{ E9 [J/bbl]} = 6.65E+17 \text{ J/yr}$
- 15 CRUDE OIL, consumption: Consumption =  $1.12E+07 \text{ Tn}$ , (Statistics Denmark, 2001). Energy,  $J = 1.12E+07 \text{ [Tn]} \times 7.3 \text{ [bbl/Tn]} \times 6.1 \text{ E9 [J/bbl]} = 4.98E+17 \text{ J/yr}$
- 16 CALCIUM CARBONATE: Production =  $3.34E+06 \text{ Tn/yr}$  (Statistics Denmark, 2001). Mass (g) =  $3.34E+06 \text{ [Tn/yr]} \times 1E6 \text{ [g/Tn]} = 3.34E+12 \text{ g/yr}$
- 17 MINERALS: Production =  $4.45E+07 \text{ Tn/yr}$  production after subtracting calcium carb. (Statistics Denmark, 2001). Mass (g) =  $4.45E+07 \text{ [Tn/yr]} \times 1E6 \text{ [g/Tn]} = 4.45E+13 \text{ g/yr}$
- 18 TOPSOIL: Energy,  $J = 3.19E+15 \text{ [J/yr}$ , (Schjønning, 1995)] see 1999 agriculture analysis for energy calculations

### **IMPORTS OF OUTSIDE ENERGY SOURCES:**

- 19 COAL: Imports =  $7.18E+06 \text{ Tn/yr}$  (Statistics Denmark, 2001). Energy,  $J = 7.18E+06 \text{ [Tn/yr]} \times 3.18 \text{ E10 [J/Tn]} = 2.28E+17 \text{ J/yr}$
- 20 CRUDE OIL: Imports =  $5.30E+06 \text{ Tn/yr}$  (Statistics Denmark, 2001). Energy,  $J = 5.30E+06 \text{ [Tn/yr, (Statistics Denmark, 2001)]} \times 7.3 \text{ [bbl/Tn]} \times 6.1 \text{ E9 [J/barrel]} = 2.36E+17 \text{ J/yr}$
- 21 OIL DERIVED PRODUCTS: Imports =  $5.44E+06 \text{ Tn/yr}$  (Statistics Denmark, 1999c), SITC Code 334. Energy,  $J = 5.44E+06 \text{ [Tn/yr]} \times 6.4 \text{ [bbl/Tn]} \times 5.83 \text{ E6 [Btu/bbl]} \times 1054 \text{ [J/Btu]} = 2.14E+17 \text{ J/yr}$
- 22 METALS: Imports =  $3.25E+06 \text{ Tn/yr}$  (Statistics Denmark, 1999c), SITC Codes 28,67,68,69. Mass (g) =  $3.25E+06 \text{ [Tn/yr]} \times 1E+6 \text{ [g/Tn]} = 3.25E+12 \text{ g/yr}$
- 23 MINERALS : Imports =  $6.39E+06 \text{ Tn/yr}$  (Statistics Denmark, 1999c), SITC Codes 27,66. Mass (g) =  $6.39E+06 \text{ [Tn/yr]} \times 1E+6 \text{ [g/Tn]} =$

6.39E+12 g/yr

- 24 FOOD and AGRICULTURAL PRODUCTS: Imports = 5.96E+06 Tn/yr (Statistics Denmark, 1999c), SITC Codes 04,05,06,07,08,09,10,11,12,292,421,422. Energy, J = 5.96E+06 [Tn/yr] x 1E+6 [g/Tn] x 3.5 [Kcal/g] x 4186 [J/Kcal] x 0.8 [80% dry matter] = 6.99E+16 J/yr
- 25 LIVESTOCK, MEAT, FISH: Imports = 1.46E+06 Tn/yr (Statistics Denmark, 1999c), SITC Codes 00,01,02,03,291,411, 431. Energy, J = 1.46E+06 [Tn/yr] x 1E+6 [g/Tn] x 5 [Kcal/g] x 4186 [J/Kcal] x 0.22 [22% protein by weight] = 6.74E+15 J/yr
- 26 FISHERIES PRODUCTION: 1.36E+06 Tn. Total catch landed in Denmark from international waters \*data for 1998 (Statistics Denmark, 1999a). Energy, J = 1.36E+06 [Tn] x 1E+06 [g/MT] x 5 [Cal/g] x .2 [20% protein content, as decimal] x 4186 [J/Cal] = 5.71E+15 J/yr
- 27 PLASTICS & RUBBER: Imports = 1.02E+06 Tn/yr (Statistics Denmark, 1999c), SITC Codes 231,232,57,58,62. Mass (g) = 1.02E+06 [Tn/yr] x 1E+6 [g/Tn] = 1.02E+12 g/yr
- 28 CHEMICALS: Imports = 3.05E+06 Tn/yr (Statistics Denmark, 1999c), SITC Codes 51,52,53,54,55,56,59 Mass (g) = 3.05E+06 [Tn/yr] x 1E+6 [g/Tn] = 3.05E+12 g/yr
- 29 WOOD, PAPER, TEXTILES, LEATHER: Imports = 4.83E+06 Tn/yr (Statistics Denmark, 1999c), [Mix of imports approx. 60% wood, 35% paper, 5%, leather and textiles] SITC Codes 21,24,25,26,61,63,64,65,81,82,83,84,85 Energy, J = 4.83E+06 [Tn/yr] x 1E+6 [g/Tn] x 1.5E+4 [J/g] = 7.24E+16 J/yr
- 30 MACHINERY, TRANSPORTATION, EQUIPMENT: Imports = 1.70E+06 Tn/yr (Statistics Denmark, 1999c), SITC Codes 71,72,73,74,75,76,77,78, 79,87,88,89. Mass (g) = 1.70E+06 [Tn/yr] x 1E+6 [g/Tn] = 1.70E+12 g/yr
- 31 IMPORTED SERVICES: USD Dollar value = 4.45E+10 USD (Statistics Denmark, 1999) [Main trading partners, Germany, Sweden, UK, Netherlands, USA, Italy, France in terms of economic value. Sej/\$ of trading partners (Switz, Japan, Spain, Netherland, W. Germ., USA) from Odum, 1996]
- 32 TOURISM: Dollar Value = 3.07E+09 USD (Statistics Denmark, 1999) [Sej/\$ of trading partners (Switz, Japan, Spain, Netherland, W. Germ., USA) from Odum, 1996]

### **EXPORTS OF ENERGY, MATERIALS AND SERVICES:**

- 33 COAL: Exports = 2.02E+05 Tn/yr (Statistics Denmark, 2001). Energy, J = 2.02E+05 [Tn/yr] x 3.18E+10 [J/Tn] = 6.42E+15 J/yr
- 34 CRUDE OIL: Exports = 9.02E+06 Tn/yr (Statistics Denmark, 2001). Energy, J = 9.02E+06 [Tn] x 7.3 [bbl/Tn] x 6.1E+09 [J/bbl] = 4.02E+17 J/yr
- 35 OIL DERIVED PRODUCTS: Exports = 4.74E+06 Tn/yr (Statistics Denmark, 2001). Energy, J = 4.74E+06 [Tn] x 6.4 [bbl/Tn] x 5.83 E6 [Btu/barrel] x 1054 [J/Btu] = 1.87E+17 J/yr
- 36 NATURAL GAS: Exports = 2.95E+09 m<sup>3</sup>/yr (Statistics Denmark, 1999). Energy, J = 2.95E+09 [m<sup>3</sup>/yr] x 35.31 [ft<sup>3</sup>/m<sup>3</sup>] x 1.055E+6 [J/



- ft<sup>3</sup>) = 1.10E+17 J/yr
- 37 METALS: Exports = 2.74E+06 Tn/yr (Statistics Denmark, 1999c), SITC Codes 28,67,68,69. Mass (g) = 2.74E+06 [Tn/yr] × 1E+6 [g/Tn] = 2.74E+12 g/yr
- 38 MINERALS: Exports = 4.97E+06 Tn/yr (Statistics Denmark, 1999c), SITC Codes 27,66. Mass (g) = 4.97E+06 [Tn/yr] × 1E+6 [g/Tn] = 4.97E+12 g/yr
- 39 FOOD and AGRICULTURAL PRODUCTS: Exports = 5.89E+06 Tn/yr (Statistics Denmark, 1999c), SITC Codes 04,05,06,07,08,09,10,11,12,292,421,422. Energy, J = 5.89E+06 [Tn/yr] × 1E+6 [g/Tn] × 3.5 [Kcal/g] × 4186 [J/Kcal] × 0.8 [80% dry matter] = 6.91E+16 J/yr
- 40 LIVESTOCK, MEAT, FISH: Exports = 3.06E+06 Tn/yr (Statistics Denmark, 1999c), SITC Codes 00,01,02,03,291,411,431. Energy, J = 1.46E+06 [Tn/yr] × 1E+6 [g/Tn] × 5 [Kcal/g] × 4186 [J/Kcal] × 0.22 [22% protein by weight] = 1.41E+16 J/yr
- 41 WOOD, PAPER, TEXTILES, LEATHER: Exports = 2.27E+06 Tn/yr (Statistics Denmark, 1999c), SITC Codes 21,24,25,26,61,63,64,65,81,82,83,84,85. Energy, J = 2.27E+06 [Tn/yr] × 1E+6 [g/Tn] × 1.5E+4 [J/g] = 2.74E+16 J/yr
- 42 CHEMICALS: Exports = 1.43E+07 Tn/yr (Statistics Denmark, 1999c), SITC Codes 51,52,53,54,55,56,59. Mass (g) = 3.05E+06 [Tn/yr] × 1E+6 [g/Tn] = 1.43E+13 g/yr
- 43 MACHINERY, TRANSPORTATION, EQUIPMENT: Imports = 1.57E+06 Tn/yr (Statistics Denmark, 1999c), SITC Codes 71,72,73,74,75,76,77,78,79,87,88,89. Mass (g) = 1.57E+06 [Tn/yr] × 1E+6 [g/Tn] = 1.57E+12 g/yr
- 44 PLASTICS & RUBBER: Imports = 2.13E+05 Tn/yr (Statistics Denmark, 1999c), SITC Codes 231,232,57,58,62. Mass (g) = 1.02E+06 [Tn/yr] × 1E+6 [g/Tn] = 2.13E+11 g/yr
- 45 SERVICES IN EXPORTS: USD Dollar Value = 4.95E+10 USD (Statistics Denmark, 1999c)

## **Footnotes to Table 4.8, emergy analysis of Danish agriculture, 1936.**

### **RENEWABLE RESOURCES:**

- 1 SOLAR ENERGY: Energy received on land, J = 32,500,000,000 [m<sup>2</sup>, total land area in agriculture (Statistics Denmark, 1968a)] × 3.70E+03 [MJ/m<sup>2</sup>/yr, avg. insolation (The Royal Danish Geographic Institute, 1986)] × 1-0.30 [1-albedo] × 1+E6 [J/MJ] = 8.42E+19 J/yr
- 2 WIND ENERGY: Surface wind is 60% of the wind speed at 1000 m; i.e. 40% of the wind speed is absorbed. Average wind speed at ground = 7.0 m/s (\* estimate from Statistics Denmark, 1971a, 1937) Energy received on land, J = 1000 [m, height of boundary layer] × 1.23 [kg/m<sup>3</sup>, density of air] × 32500000000 [m<sup>2</sup>, area] × (0.4 [40%] × 7.0 [m/s, wind speed] / 0.6 [60% of wind speed absorbed at ground])<sup>2</sup> / 2 = 4.35E+14 J/yr

- 3 RAIN, CHEMICAL POTENTIAL ENERGY: Energy, J = 656 [mm/yr, precipitation (Statistics Denmark, 1937)] × 32500000000 [m<sup>2</sup>, farmed area] × .001 [m/mm] × 1+E6 [g/m<sup>3</sup>] × 4.94 [J/g, Gibbs free energy] × 1 - 0.0683 [1- runoff coefficient (Hansen, A. & Nielsen, J.D.,1995)] = 9.81E+16 J/yr
- 4 EARTH CYCLE: Energy, J = 32500000000 [m<sup>2</sup>, land area] × 1.00E+06 [J/m<sup>2</sup>, heat flow, estimate from Odum, 1996] = 3.25E+16 J/yr

### **NONRENEWABLE STORAGES (N):**

- 5 TOPSOIL LOSS: Topsoil loss = (erosion rate) × (farmed area) × (% organic). Energy loss, J = (loss of organic matter) × (5.4 kcal/g) × (4186 J/kcal)
- Topsoil loss, J = (6.22E+04 [g/ha/yr, erosion rate of grass and hay (Hansen & Nielsen, 1995)] × 1.29E+06 [ha, farmed area grass and hay (Statistics Denmark, 1968a)] + 7.62E+05 [g/ha/yr, erosion rate of cereals and pulses (using values of topsoil loss from spring cereals from Hansen & Nielsen, 1995)] × 1.35E+06 [ha, farmed area cereals and pulses (Statistics Denmark, 1968a)] = 1.11E+12 [g/yr, total loss of topsoil] × .026 [% organic matter in soil given as decimal (Sibbesen, 1995; Schjønning, 1995)] = 2.88E+10 [g/org matter/yr] × 5.4 [kcal/g] × 4186 [J/kcal] = 6.52E+14 J/yr

### **PURCHASED INPUTS (P):**

#### *Applied energy*

- 6 FUEL: Total energy, J = 3.00E+08 [J/ha/yr, combines petrol, kerosene and diesel (Schroll, H., 1994)] × 3250000 [ha, land in agriculture (Statistics Denmark, 1968a)] = 9.75E+14 J
- 7 ELECTRICITY: Total energy, J = 4.00E+08 [J/ha/yr (Schroll, H., 1994)] × 3250000 [ha, land in agriculture (Statistics Denmark, 1968a)] = 1.30E+15 J

#### *Farm assets*

- 8 MECHANICAL EQUIPMENT: Mechanical equipment (g, steel, all data from Statistics Denmark, 1937)=
- Mobile power machines:* Total mass (kg) = 6.65E+03 [Tractors, assuming 43.5 avg. hp] × 2.50E+03 [kg, steel/tractor (ODAL Maskin AB, 1990. Kraftsamling)] + 1.27E+03 [Steam engine tractors, (Statistics Denmark, 1937)] × 2.50E+03 [kg, steel/tractor, estimate] = 1.98E+07 kg/steel
- Fixed power machines:* Total mass (kg) = 7.36E+04 [electric motors] × 1.00E+02 [kg, steel/machine, estimate] + 3.48E+04 [internal combustion engines] × 3.00E+02 [kg, steel/machine, estimate] + 1.26E+04 [windmills, farm work] × 5.00E+01 [kg, steel/machine, estimate] + 2.93E+03 [windmills, water pump] × 5.00E+01 [kg, steel/machine, estimate] = 1.86E+07 kg/steel
- Field machines:* 1.12E+05 [Seed drills (for grain)] × 2.20E+02 [kg, steel/machine, estimate] + 1.59E+04 [Broadcast seeders] × 2.20E+02 [kg, steel/machine, estimate] + 1.16E+05 [Mowing machines] ×

$2.20E+02$  [kg, steel/machine, estimate] +  $1.06E+04$  [Hay rakes] ×  $1.50E+02$  [kg, steel/machine, estimate] +  $8.23E+04$  [Reaper-binder/harvesters] ×  $8.00E+02$  [kg, steel/machine, estimate] +  $2.63E+03$  [Potato planters] ×  $2.20E+02$  [kg, steel/machine, estimate] +  $7.14E+03$  [Potato harvester] ×  $1.50E+02$  [kg, steel/machine, estimate] +  $2.00E+04$  [Root crop (turnip/beet) harvesters] ×  $1.50E+02$  [kg, steel/machine, estimate] +  $8.91E+03$  [Fertilizer spreaders] ×  $2.20E+02$  [kg, steel/machine, estimate] +  $3.08E+03$  [Copper sulfate spreaders (by horse power)] ×  $2.20E+02$  [kg, steel/machine, estimate] +  $5.51E+03$  [Liquid manure spreaders] ×  $2.20E+02$  [kg, steel/machine, estimate] =  $1.30E+08$  kg/steel

*Machines in Stalls and Barns:*  $1.39E+04$  [Large self-cleaning threshing machines w/ roller] ×  $1.00E+03$  [kg, steel/machine, estimate] +  $2.97E+04$  [Double cleaning threshing machines w/o roller] ×  $1.00E+03$  [kg, steel/machine, estimate] +  $6.54E+04$  [Smaller single-cleaning threshing machines] ×  $5.00E+02$  [kg, steel/machine, estimate] +  $3.32E+04$  [Threshing machines without cleaner] ×  $5.00E+02$  [kg, steel/machine, estimate] +  $2.93E+04$  [Straw presses w/ binder] ×  $8.00E+02$  [kg, steel/machine, estimate] +  $1.45E+04$  [Straw presses w/o binder] ×  $8.00E+02$  [kg, steel/machine, estimate] +  $8.61E+04$  [Grinding mills] ×  $1.50E+02$  [kg, steel/machine, estimate] +  $1.40E+05$  [Chaff cutter] ×  $1.50E+02$  [kg, steel/machine, estimate] +  $2.20E+03$  [Root crop washers] ×  $1.50E+02$  [kg, steel/machine, estimate] +  $3.36E+03$  [Root crop dryers] ×  $1.50E+02$  [kg, steel/machine, estimate] +  $3.64E+03$  [Milking Machines] ×  $1.50E+02$  [kg, steel/machine, estimate] =  $1.62E+08$  kg/steel

Total mass (g) =  $3.39E+08$  × 1000 [g/kg] =  $3.39E+11$  g

$3.39E+11$  g / 15 [yrs, depreciation rate] =  $2.21E+10$  g/yr

- 9 BUILDINGS, value USD: 880 [DKK, value/ha (Statistics Denmark, 1937)] ×  $3.25E+06$  [ha (Statistics Denmark, 1937)] = 2,860,000,000 [total value, DKK] / 4.5 [DKK/USD exchange rate (Statistics Denmark, 1937)] = 636,000,000 USD / 30 [depreciation rate, 30 years] =  $2.12E+07$  USD, yearly contribution

*Goods for crop production*

10 POTASSIUM, g K: Total use (purchased) =  $3.25E+10$  g/yr [tonnage used × percent raw nutrient (Statistics Denmark, 1968)]

11 PHOSPHATE, g P: Total use (purchased) =  $6.53E+10$  g/yr [tonnage used × percent raw nutrient (Statistics Denmark, 1968)]

12 NITROGEN, g N: Total use (purchased) =  $3.19E+10$  g/yr [tonnage used × percent raw nutrient (Statistics Denmark, 1968)]

*Goods for livestock production*

13 IMPORTED CEREALS: Imported cereals (mostly wheat, rye and corn) =  $8.52E+11$  [g, national figure, all may not go to livestock (Statistics Denmark, 1937)] × 3.27 [kcal/g, energy content (Francis, 2000)] =  $2.79E+12$  kcal × 4186 [J/kcal] =  $1.17E+16$  J

14 IMPORTED FEEDS: Imported feed concentrates, by digestible crude protein (all data from Statistics Denmark, 1968b)

Total energy, J = 24000 [J/g] × (2.03E+11 [g, cereals and pulses] + 1.30E+10 [g, bran, fodder meal] + 2.71E+11 [g, oil-cakes] + 1.00E+10 [g, meat and bone meal, fish meal, etc.] + 1.35E+11 [g, milk and milk powder, etc.]) = 1.52E+16 J

### **SERVICES and LABOR (S):**

15 Services and Labor (\$) = 5.57E+02 [kr/ha/yr, total production value] × 3250000 [ha] / 4.5 [DKK/USD] = 4.02E+08 [USD, total service]

### **CROP PRODUCTION:**

16 Data for crop production from (Statistics Denmark, 1968a)

Total production, J = (3.13E+11 [g, spring wheat] + 2.02E+11 [g, rye] + 6.48E+11 [g, mixed grains] + 9.17E+11 [g, spring barley] + 8.54E+11 [g, oats] × 16000 [J/g, (Schroll, 1994)]) + (7.67E+09 [g, pulses] × 0.83 [kcal/g (Holland et al., 1993)] × 4186 [J/kcal]) + (4.06E+12 [g, straw] × 15 [kJ/g, (Duke, 1983)] × 1000 [J/kJ]) + (1.31E+12 [g, potatoes] × 0.7 [kcal/g (Holland et al., 1993)] × 4186 [J/kcal]) + (1.47E+12 [g, sugar beets] × 0.67 [kcal/g (Ulgiati et al., 1994)] × 4186 [J/kcal]) + (1.08E+12 [g, fodder beets and sugar beets for feed] × 2.09E+03 [J/g (Schroll, 1994)]) + (1.20E+13 [g, swedes] × 2.09E+03 [J/g (Schroll, 1994)]) + (8.48E+11 [g, turnips] × 2.09E+03 [J/g (Schroll, 1994)]) + (9.37E+12 [g, mangolds] × 2.09E+03 [J/g (Schroll, 1994)]) + (1.31E+11 [g, carrots] × 2.09E+03 [J/g (Schroll, 1994)]) + (3.44E+11 [g, beet tops] × 0.45 [kcal/g (Holland et al., 1993)] × 4186 [J/kcal]) + (8.12E+12 [g, grass, green fodder and aftermath] × 3.82E+03 [J/g (Schroll, 1994)]) = 1.97E+17 J

### **LIVESTOCK PRODUCTION:**

17 Data for livestock production from (Statistics Denmark, 1968b)

Total production, J = (1.78E+11 [g, beef and veal] × 2.52 [kcal/g (Holland et al., 1993)] × 4186 [J/kcal]) + (3.47E+11 [g, pork] × 3.81 [kcal/g (Holland et al., 1993)] × 4186 [J/kcal]) + (2.57E+10 [g, poultry] × 2.30 [kcal/g (Holland et al., 1993)] × 4186 [J/kcal]) + (3.30E+09 [g, horse meat] × 2.52 [kcal/g (Holland et al., 1993)] × 4186 [J/kcal]) + 2.90E+09 [g, mutton and lamb] × 3.78 [kcal/g (Holland et al., 1993)] × 4186 [J/kcal] + (5.21E+12 [g, milk] × 0.66 [kcal/g (Holland et al., 1993)] × 4186 [J/kcal]) + (1.15E+11 [g, eggs] × 1.47 [kcal/g (Holland et al., 1993)] × 4186 [J/kcal]) = 2.28E+16 J

## **Footnotes to Table 4.10, energy analysis of Danish agriculture, 1970.**

### **RENEWABLE RESOURCES:**

1 SOLAR ENERGY: Energy received on land, J = 29,413,160,000 [m<sup>2</sup>, total land area in agriculture (Statistics Denmark, 1972)] × 3.70E+03 [MJ/m<sup>2</sup>/yr, avg. insolation (The Royal Danish Geographic Insti-

- tute, 1986)] x 1-0.30 [1-albedo] x 1+E6 [J/MJ] = 7.62E+19 J/yr
- 2 WIND ENERGY: Surface wind is 60% of the wind speed at 1000m; i.e. 40% of the wind speed is absorbed. Average wind speed at ground = 7.0 m/s (\* estimate from Statistics Denmark, 1971a, 1937) Energy received on land, J = 1000 [m, height of boundary layer] x 1.23 [kg/m<sup>3</sup>, density of air] x 29413160000 [m<sup>2</sup>, area] x (0.4 [40%] x 7.0 [m/s, wind speed] / 0.6 [60% of wind speed absorbed at ground])<sup>2</sup> / 2 = 3.54E+14 J/yr
- 3 RAIN, CHEMICAL POTENTIAL ENERGY: Energy, J = 758 [mm/yr, precipitation (Statistics Denmark, 1971)] x 29413160000 [m<sup>2</sup>, farmed area] x .001 [m/mm] x 1+E6 [g/m<sup>3</sup>] x 4.94 [J/g, Gibbs free energy] x 1 - 0.0683 [1- runoff coefficient (Hansen, A. & Nielsen, J.D.,1995)] = 1.03E+17 J/yr
- 4 EARTH CYCLE: Energy, J = 29413160000 [m<sup>2</sup>, land area] x 1.00E+06 [J/m<sup>2</sup>, heat flow, estimate from Odum, 1996] = 2.94E+16 J/yr

### **NONRENEWABLE STORAGES (N):**

- 5 TOPSOIL LOSS: Topsoil loss = (erosion rate) x (farmed area) x (% organic). Energy loss, J = (loss of organic matter)x(5.4 kcal/g)x(4186 J/kcal)
- Net topsoil loss, J = 6.22E+04 [g/ha/yr, erosion rate of grass and hay (Hansen & Nielsen, 1995)] x 8.00E+05 [ha, farmed area grass and hay (Statistics Denmark, 1972)] + 7.62E+05 [g/ha/yr, erosion rate of cereals and pulses (using values of topsoil loss from spring cereals from Hansen & Nielsen, 1995)] x 1.62E+06 [ha, farmed area cereals and pulses (Statistics Denmark, 1972)] + 6.38E+06 [g/ha/yr, erosion rate of winter cereals from Hansen & Nielsen (1995)] x 1.22E+05 [ha, farmed area cereals and pulses (Statistics Denmark, 1972)] = 2.06E+12 [g/yr, total loss of topsoil] x .026 [% organic matter in soil given as decimal (Sibbesen, 1995; Schjøning, 1995)] = 5.35E+10 [g, org matter/yr] x 5.4 [kcal/g] x 4186 [J/kcal] = 1.21E+15 J/yr

### **PURCHASED INPUTS (P):**

#### *Applied energy*

- 6 FUEL: Total energy, J = 3.80E+9 [J/ha/yr, combines petrol, kerosene and diesel (Schroll, H., 1994)] x 2941316 [ha, land in agriculture (Statistics Denmark, 1972)] = 1.12E+16 J
- 7 ELECTRICITY: Total energy, J = 3.00E+09 [J/ha/yr (Schroll, H., 1994)] x 2941316 [ha, land in agriculture (Statistics Denmark, 1968a)] = 8.82E+15 J

#### *Farm assets*

- 8 MECHANICAL EQUIPMENT: Mechanical equipment (g, steel from Schroll, 1994) = 1.21E+11 g/yr
- 9 BUILDINGS, value USD: Maintenance on buildings, 1969= 9.89E+07 (Statistics Denmark, 1972)

#### *Goods for crop production*

- 10 POTASSIUM, g K: Total use =  $1.52E+11$  [g/yr, raw nutrient (Statistics Denmark, 1972)]
- 11 PHOSPHATE, g P: Total use =  $5.54E+10$  [g/yr, raw nutrient (Statistics Denmark, 1972)]
- 12 NITROGEN, g N: Total use (purchased) =  $2.71E+11$  g/yr [g/yr, raw nutrient (Statistics Denmark, 1972)]
- 13 PESTICIDES, g active substance (includes pesticides, fungicides, herbicides)  
Total use (g) =  $2$  [kg/ha, active substance (Schroll, 1994)]  $\times$   $2941316$  [ha]  $\times$   $1000$  [g/kg] =  $5.88E+09$  g/yr

#### *Goods for livestock production*

- 14 IMPORTED CEREALS: Imported cereals =  $6.16E+11$  [g, (Statistics Denmark, 1972)]  $\times$   $3.27$  [kcal/g, energy content (Francis, 2000)] =  $2.01E+12$  kcal  $\times$   $4186$  [J/kcal] =  $8.43E+15$ , J
- 15 IMPORTED FEEDS: Imported feed concentrates, by digestible crude protein (all data from Statistics Denmark, 1972)  
Total energy, J =  $24000$  [J/g, protein (Brandt-Williams, 2001)]  $\times$  ( $3.90E+10$  [g, cereals and pulses] +  $1.10E+10$  [g, bran, fodder meal] +  $3.75E+11$  [g, oil-cakes] +  $5.10E+10$  [g, Mash, draff, yeast and molasses] +  $1.20E+10$  [g, meat and bone meal, fish meal, etc.] +  $8.00E+09$  [g, milk and milk powder, etc.]) =  $1.19E+16$  J

#### **SERVICES and LABOR (S):**

- 16 Services and Labor (\$) =  $5138$  [DKK/ha, total farm income (Statistics Denmark, 1972)]  $\times$   $2941316$  [ha, (Statistics Denmark, 1972)] /  $7.5$  [DKK/USD] =  $2.01E+09$  USD

#### **CROP PRODUCTION:**

- 17 Data for crop production from (Statistics Denmark, 1972)  
Total production, J = ( $3.85E+11$  [g, winter wheat] +  $1.27E+11$  [g, spring wheat] +  $1.34E+11$  [g, rye] +  $1.42E+11$  [g, mixed grains] +  $4.81E+12$  [g, spring barley] +  $6.31E+11$  [g, oats])  $\times$   $16000$  [J/g, (Schroll, 1994)] + ( $9.30E+10$  [g, pulses]  $\times$   $0.83$  [kcal/g (Holland et al., 1993)]  $\times$   $4186$  [J/kcal]) + ( $4.34E+12$  [g, straw]  $\times$   $15$  [kJ/g, (Duke, 1983)]  $\times$   $1000$  [J/kJ]) + ( $1.03E+12$  [g, potatoes]  $\times$   $0.7$  [kcal/g (Holland et al., 1993)]  $\times$   $4186$  [J/kcal]) + ( $1.89E+12$  [g, sugar beets]  $\times$   $0.67$  [kcal/g (Ulgiate et al., 1994)]  $\times$   $4186$  [J/kcal]) + ( $1.10E+13$  [g, fodder roots, swedes]  $\times$   $2.09E+03$  [J/g (Schroll, 1994)]) + ( $3.05E+10$  [g, seeds for sowing]  $\times$   $3.27$  [kcal/g (Francis, 2000)]  $\times$   $4186$  [J/kcal]) + ( $2.87E+10$  [g, seeds for industrial use]  $\times$   $5.77$  [kcal/g (Appelqvist, 1973)]  $\times$   $4186$  [J/kcal]) + ( $4.64E+11$  [g, beet tops]  $\times$   $0.45$  [kcal/g (Holland et al., 1993)]  $\times$   $4186$  [J/kcal]) + ( $4.19E+12$  [g, grass, green fodder and aftermath]  $\times$   $3.82E+03$  [J/g (Schroll, 1994)]) =  $2.15E+17$  J

#### **LIVESTOCK PRODUCTION:**

- 18 Data for livestock production from (Statistics Denmark, 1972)

Total production,  $J = (2.34E+11 \text{ [g, beef and veal]} \times 2.52 \text{ [kcal/g (Holland et al., 1993)]} \times 4186 \text{ [J/kcal]}) + (7.97E+11 \text{ [g, pork]} \times 3.81 \text{ [kcal/g (Holland et al., 1993)]} \times 4186 \text{ [J/kcal]}) + (8.04E+10 \text{ [g, poultry]} \times 2.30 \text{ [kcal/g (Holland et al., 1993)]} \times 4186 \text{ [J/kcal]}) + (1.80E+09 \text{ [g, horse meat]} \times 2.52 \text{ [kcal/g (Holland et al., 1993)]} \times 4186 \text{ [J/kcal]}) + 1.90E+09 \text{ [g, mutton and lamb]} \times 3.78 \text{ [kcal/g (Holland et al., 1993)]} \times 4186 \text{ [J/kcal]}) + (7.16E+12 \text{ [g, milk]} \times 0.66 \text{ [kcal/g (Holland et al., 1993)]} \times 4186 \text{ [J/kcal]}) + (7.93E+10 \text{ [g, eggs]} \times 1.47 \text{ [kcal/g (Holland et al., 1993)]} \times 4186 \text{ [J/kcal]}) = 3.63E+16 \text{ J}$

## Footnotes to Table 4.12, energy analysis of Danish agriculture, 1999.

### RENEWABLE RESOURCES:

- 1 SOLAR ENERGY: Energy received on land,  $J = 26,440,000,000 \text{ [m}^2\text{, total land area in agriculture (Statistics Denmark, 1999a)]} \times 3.70E+03 \text{ [MJ/m}^2\text{/yr, avg. insolation (The Royal Danish Geographic Institute, 1986)]} \times 1-0.30 \text{ [1-albedo]} \times 1+E6 \text{ [J/MJ]} = 6.85E+19 \text{ J/yr}$
- 2 WIND ENERGY: Surface wind is 60% of the wind speed at 1000 m; i.e. 40% of the wind speed is absorbed. Average wind speed at ground = 7.0 m/s (\* estimate from Statistics Denmark 1999, 1971a, 1937) Energy received on land,  $J = 1000 \text{ [m, height of boundary layer]} \times 1.23 \text{ [kg/m}^3\text{, density of air]} \times 29413160000 \text{ [m}^2\text{, area]} \times (0.4 \text{ [40%]} \times 7.0 \text{ [m/s, wind speed]} / 0.6 \text{ [60% of wind speed absorbed at ground]})^2 / 2 = 3.54E+14 \text{ J/yr}$
- 3 RAIN, CHEMICAL POTENTIAL ENERGY: Energy,  $J = 834 \text{ [mm/yr, precipitation (Statistics Denmark, 1999a)]} \times 26440000000 \text{ [m}^2\text{, farmed area]} \times .001 \text{ [m/mm]} \times 1+E6 \text{ [g/m}^3\text{]} \times 4.94 \text{ [J/g, Gibbs free energy]} \times 1 - 0.0683 \text{ [1- runoff coefficient (Hansen, A. & Nielsen, J.D.,1995)]} = 1.01E+17 \text{ J/yr}$
- 4 EARTH CYCLE: Energy,  $J = 26440000000 \text{ [m}^2\text{, land area]} \times 1.00E+06 \text{ [J/m}^2\text{, heat flow, estimate from Odum, 1996]} = 2.64E+16 \text{ J/yr}$

### NONRENEWABLE STORAGES (N):

- 5 TOPSOIL LOSS: Topsoil loss = (erosion rate) x (farmed area) x (% organic). Energy loss,  $J = (\text{loss of organic matter}) \times (5.4 \text{ kcal/g}) \times (4186 \text{ J/kcal})$   
 Net topsoil loss,  $J = 6.22E+04 \text{ [g/ha/yr, erosion rate of grass and hay (Hansen & Nielsen, 1995)]} \times 7.56E+05 \text{ [ha, farmed area grass and hay (Statistics Denmark, 1999b)]} + 7.62E+05 \text{ [g/ha/yr, erosion rate of cereals and pulses (using values of topsoil loss from spring cereals from Hansen & Nielsen, 1995)]} \times 6.86E+05 \text{ [ha, farmed area spring cereals (Statistics Denmark, 1999b)]} + 6.38E+06 \text{ [g/ha/yr, erosion rate of winter cereals from Hansen & Nielsen (1995)]} \times 7.62E+05 \text{ [ha, farmed area cereals and pulses (Statistics Denmark, 1972)]} = 5.43E+12 \text{ [g/yr, total loss of topsoil]} \times .026 \text{ [% organic matter in soil given as decimal (Sibbesen, 1995; Schjønning,$

$$1995) = 1.41E+11 \text{ [g, org matter/yr]} \times 5.4 \text{ [kcal/g]} \times 4186 \text{ [J/kcal]} \\ = 3.19E+15 \text{ J/yr}$$

## **PURCHASED INPUTS (P):**

### *Applied energy*

- 6 DIESEL: Total energy content,  $J = 468000000 \text{ [kg/yr, (Statistics Denmark, 1999a)]} \times 1.2 \text{ [l/kg]} \times 3.87E+07 \text{ [J/l (United States Department of Energy, 2001)]} = 2.17E+16 \text{ J}$
- 7 COAL: Total energy content,  $J = 5.00E+04 \text{ [Tn/yr, (Statistics Denmark, 1999a)]} \times 3.18E+10 \text{ [J/Tn (Odum, 1996)]} = 1.59E+15 \text{ J}$
- 8 GASOLINE: Total energy content =  $2.00E+03 \text{ [Tn/yr, (Statistics Denmark, 1999a)]} \times 4.71E+10 \text{ [J/Tn, (United States Department of Energy, 2001)]} = 9.42E+13 \text{ J}$
- 9 FUEL OIL, J: Total energy content,  $J = 2.75E+15 \text{ J (Statistics Denmark, 1999a)}$
- 10 NATURAL GAS: Total energy content,  $J = 4.082E+15 \text{ J (Statistics Denmark, 1999a)}$
- 11 ELECTRICITY: Total energy use,  $J = 1.68E+09 \text{ [kWh/yr, (Statistics Denmark, 1999a)]} \times 3.6E6 \text{ [J/kWh]} = 6.05E+15 \text{ J}$

### *Farm assets*

- 12 MECHANICAL EQUIPMENT: Mechanical equipment, g (data from Statistics Denmark, 1999a, ODAL, 1990)  
 $= ((3.05E+04 \text{ [tractors under 54 hp (assume 43.5 avg.)]} \times 2.50E+03 \text{ [kg steel/tractor]} + (4.76E+04 \text{ [tractors, 54-80 hp (assume 67 avg.)]} \times 3.20E+03 \text{ [kg steel/tractor]} + (4.45E+04 \text{ [tractors, 81-134 hp (assume 107.5 avg.)]} \times 4.70E+03 \text{ [kg steel/tractor]} + (6.74E+03 \text{ [tractors, 135 hp and over (assume 162.5 avg.)]} \times 6.95E+03 \text{ [kg steel/tractor]} + (2.42E+04 \text{ [Combined and automatic harvesters]} \times 6.95E+03 \text{ [kg steel/tractor]} \times 1000 \text{ [g/kg]}) / 15 \text{ [yrs, depreciation rate]} = 4.35E+10 \text{ g/yr}$
- 13 BUILDINGS, value USD: Maintenance on buildings =  $(9.40E+03 \text{ [DKK/farm, maintenance expenditure]} \times 57841 \text{ [farms]}) / 7 \text{ [DKK/USD]} = 7.77E+07 \text{ USD}$

### *Goods for crop production*

- 14 POTASSIUM, g K: Total use =  $8.09E+10 \text{ [g/yr, raw nutrient (Statistics Denmark, 1999b)]}$
- 15 PHOSPHATE, g P: Total use =  $2.03E+10 \text{ [g/yr, raw nutrient (Statistics Denmark, 1999b)]}$
- 16 NITROGEN, g N: Total use =  $2.63E+11 \text{ g/yr [g/yr, raw nutrient (Statistics Denmark, 1999b)]}$
- 17 PESTICIDES, g active substance (includes pesticides, fungicides, herbicides)  
 Total use (g) =  $3.62E+09 \text{ [g/yr, data from 1998]}$

### *Goods for livestock production*

- 18 IMPORTED CEREALS: Imported cereals =  $3.71E+10 \text{ [g, (Statistics$



Denmark, 1999b)] × 3.27 [kcal/g, energy content (Francis, 2000)] =  
2.01E+12 kcal × 4186 [J/kcal] = 5.08E+14, J

19 IMPORTED FEEDS: Imported feed concentrates, by digestible crude protein (all data from Statistics Denmark, 1999b)

Total energy, J = 24000 [J/g, protein (Brandt-Williams, 2001)] ×  
(3.80E+10 [g, cereals and pulses] + 1.50E+10 [g, bran, fodder meal]  
+ 7.41E+11 [g, oil-cakes] + 5.10E+10 [g, Mash, draff, yeast and  
molasses] + 2.00E+09 [g, Lucerne meal] + 1.82E+11 [g, meat and  
bone meal, fish meal, etc.] + 1.00E+09 [g, milk and milk powder,  
etc.]) = 2.47E+16 J

### **SERVICES and LABOR (S):**

20 Services and Labor (\$) = 6.70E+09 [USD, gross proceeds from sale of  
ag. products]

### **CROP PRODUCTION:**

21 Data for crop production from (Statistics Denmark, 1999b)



Total production, J = (4.43E+12 [g, winter wheat] + 3.78E+10 [g, spring  
wheat] + 2.48E+11 [g, rye] + 2.51E+11 [g, triticale] + 2.79E+12 [g,  
spring barley] + 8.84E+11 [g, winter barley] + 1.30E+11 [g, oats]) ×  
16000 [J/g, (Schroll, 1994)] + (1.93E+11 [g, pulses] × 0.83 [kcal/g  
(Holland et al., 1993)] × 4186 [J/kcal]) + (3.61E+12 [g, straw] × 15  
[kJ/g, (Duke, 1983)] × 1000 [J/kJ]) + (1.50E+12 [g, potatoes] × 0.7  
[kcal/g (Holland et al., 1993)] × 4186 [J/kcal]) + (3.55E+12 [g, sugar  
beets] × 0.67 [kcal/g (Ulgiati et al., 1994)] × 4186 [J/kcal]) +  
(1.50E+12 [g, fodder roots, swedes] × 2.09E+03 [J/g (Schroll, 1994)])  
+ (8.64E+10 [g, seeds for sowing] × 3.27 [kcal/g (Francis, 2000)] ×  
4186 [J/kcal]) + (5.12E+09 [g, seeds for industrial use] × 5.77 [kcal/  
g (Appelqvist, 1973)] × 4186 [J/kcal]) + (3.44E+11 [g, beet tops] ×  
0.45 [kcal/g (Holland et al., 1993)] × 4186 [J/kcal]) + (2.15E+13 [g,  
grass, green fodder and aftermath] × 3.82E+03 [J/g (Schroll, 1994)])  
+ (3.49E+11 [g, winter rape] × 5.77 [kcal/g (Appelqvist, 1973)] ×  
4186 [J/kcal]) + (6.26E+10 [g, winter rape] × 5.77 [kcal/g  
(Appelqvist, 1973)] × 4186 [J/kcal]) = 2.26E+17 J

### **LIVESTOCK PRODUCTION:**

22 Data for livestock production from (Statistics Denmark, 1999b)

Total production, J = (1.73E+11 [g, beef and veal] × 2.52 [kcal/g (Hol-  
land et al., 1993)] × 4186 [J/kcal]) + (1.78E+12 [g, pork] × 3.81 [kcal/  
g (Holland et al., 1993)] × 4186 [J/kcal]) + (2.05E+11 [g, poultry] ×  
2.30 [kcal/g (Holland et al., 1993)] × 4186 [J/kcal]) + (1.40E+09 [g,  
horse meat] × 2.52 [kcal/g (Holland et al., 1993)] × 4186 [J/kcal]) +  
1.50E+09 [g, mutton and lamb] × 3.78 [kcal/g (Holland et al., 1993)]  
× 4186 [J/kcal]) + (4.66E+12 [g, milk] × 0.66 [kcal/g (Holland et al.,  
1993)] × 4186 [J/kcal]) + (7.82E+10 [g, eggs] × 1.47 [kcal/g (Holland  
et al., 1993)] × 4186 [J/kcal]) = 4.56E+16 J

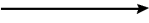
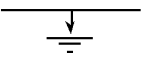
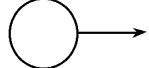
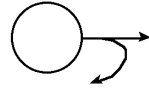
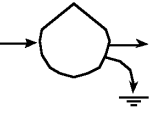
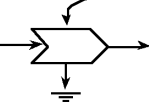
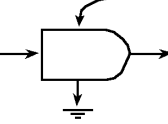
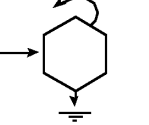
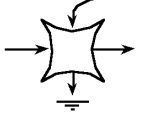
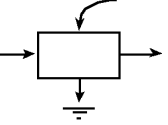
# APPENDIX C – SYMBOLS OF THE ENERGY SYSTEMS LANGUAGE

	<i>Energy circuit:</i> A pathway whose flow is proportional to the quantity in the storage or source upstream.
	<i>Heat sink:</i> Dispersion of potential energy into heat that accompanies all real transformation processes and storages; loss of potential energy from further use by the system.
	<i>Force-controlled source:</i> External energy source with constant availability, delivering an unlimited supply in proportion to demand.
	<i>Flow-controlled source/renewable source:</i> An energy source with only a set amount of flowing and available per unit time.
	<i>Tank:</i> A compartment of energy storage within a system storing a quantity as the balance of inflows and outflows; a state variable.
	<i>Interaction:</i> Interactive intersection of two pathways coupled to produce an outflow in proportion to a function of both; control action of one flow on another; limiting factor action; work gate.
	<i>Producer:</i> Unit that collects and transforms low-quality energy under control interactions of high-quality flows.
	<i>Consumer:</i> Unit that transforms energy quality, stores it, and feeds it back autocatalytically to improve inflow.
	<i>Switching action:</i> A symbol that indicates one or more switching actions.
	<i>Box:</i> Miscellaneous symbol to use for whatever unit or function is labeled.
	<i>Transaction:</i> A unit that indicates a sale of goods or services (solid line) in exchange for payment of money (dashed line). Price is shown as an external source.

Symbols redrawn after Odum (1971, 1994a, 1996).

### I denna serie har utkommit:

1. Næss, H. 1988. Alternativ odling på Ekenäs gård. Biologiska och ekonomiska konsekvenser.
2. Brorsson, K-Å. 1989. Ekonomiska effekter av omställningsbidrag till alternativ odling.
3. Andersson, M. 1989. Alternativodlade köksväxter – en expanderande marknad.
4. Granstedt, A. 1990. Fallstudier av kväveförsörjning i alternativ odling.
5. Granstedt, A. 1990. Proceedings of Ecological Agriculture. NJF-Seminar 166. March 1990. Sektion XI – Miljövard.
6. Granstedt, A. 1990. Nödvändigheten av en naturresursbaserad jordbrukspolitik och hur en sådan kan förverkligas.
7. Svensson, I. 1991. Statligt stöd till alternativ odling 1989. En enkätundersökning.
8. Rydberg, T. 1991. Ogräsharvning – inledande studier av ogräsharvning i stråsåd.
9. Günther, F. 1991. Jordbruk och bosättning i samverkan – en lösning på miljöproblemen.
10. Sobelius, J. & Granstedt, A. 1992. Omläggning till ekologiskt lantbruk. Del I. En litteraturstudie.
11. Sobelius, J. 1992. Omläggning till ekologiskt lantbruk. Del II. Biodynamiskt lantbruk i Skåne, Blekinge och Halland.
12. Nilsson, E. & Salomonsson, L. 1991. Agroecosystems and ecological settlements. Colloquium in Uppsala, May 27th – 31th. 1991.
13. Höök, K. & Wivstad, M. 1992. Ekologiskt lantbruk inför framtiden. 1991 års konferens om ekologiskt lantbruk, 12 – 13 november 1991.
14. Granstedt, A. 1992. Nordisk forskar- och rådgivarträff i Öjebyn den 8 – 9 augusti 1991. Studieresa till ekokommunen Övertorneå den 10 augusti 1991.
15. Höök, K. 1993. Baljväxter som grüngödslingsgröda. En kartläggning av arter och sorter i fältexperiment.
16. Ekblad, G. & Ekelund Axelsson, L. & Mattsson, B. 1993. Ekologisk grönsaksodling – En företagsstudie.
17. Höök, K. & Sandström, M. 1994. Konferens Ekologiskt lantbruk. Uppsala den 23 – 24 november 1993.
18. Mathisson, K. & Schollin, A. 1994. Konsumentaspekter på ekologiskt odlade grönsaker – en jämförande studie.
19. Ekblad, G. 1998. Utvärdering av odlingsåtgärder för ekologisk grönsaksproduktion – undersökningar inom forskningsprogrammet "Alternativa produktionsformer inom trädgårdsnäringen".
20. Sundås, S. 1996. Konferens Ekologiskt lantbruk. Uppsala den 7 – 8 november 1995.
21. Pettersson, P. 1997. Forage quality aspects during conversion to ecological agriculture. A study with multivariate and near infrared spectroscopy.
22. Gäredal, L. 1998. Växthusodling av tomat (*Lycopersicon esculentum* Mill.) i avgränsad odlingsbädd, baserad på näringsresurser från lokalt producerad stallgödselkompost och grönmassa.
23. Eksvärd, K. 1998. Från idé till samverkan – en undersökning av möjligheterna att lägga om systemen för toalett- och organiskt hushållsavfall i Fornbo.
24. Eksvärd, K. 1998. Mjuka starter och ödmjukt deltagande – nödvändiga inslag i processen uthålligt lantbruk?
25. Granstedt, A. & L-Baeckström, G. 1998. Studier av vallens förfruktvärde i ekologisk odling – Resultat från två försöksplatser i Mellansverige.
26. Granstedt, A. Stallgödselanvändning i ekologisk odling – Resultat från fältförsök i höstvetete på Skilleby i Järna 1991 – 1997.
27. Under bearbetning
28. Ekologiskt lantbruk 10 – mars 1998. Konferensrapport.
29. Granstedt, A. 1999. Växtnäringens flöde genom jordbruk och samhälle – vägar att sluta kretsloppen.
30. Ekologisk jordbruks- & trädgårdsproduktion. Redovisning av SJFR:s forskningsprogram 1997 – 1999.
31. Eksvärd, K., m.fl. Deltagande forskning – Lärdomar, resultat och erfarenheter från Växthusgruppens arbete 1999 – 2000.

32. Doherty, S. and Rydberg, T. (ed.), Ekbladh, G., Grönlund, E., Ingemarson, F., Karlsson, L., Nilsson, S. & Strid Eriksson, I. 2002. Ecosystem properties and principles of living systems as foundation for sustainable agriculture – Critical reviews of environmental assessment tools, key findings and questions from a course process.
33. Ciszuk, P., Sjelín, K. & Sjelín, Y., 2002, Vandringshönshus med olika inredning, gruppstorlek och utfodringssystem.
34. Bassler, A. & Ciszuk, P. 2002. Pilot studies in organic broiler production – Management and Cross-breeds.
35. Svanäng, K. m.fl. Deltagardriven forskning – växtodlingsgruppen. Resultat och utvärdering av arbetet under 1998 till 2001.
36. Rydén, R. Medvindens tid. Ekologiska Lantbrukarna och jordbrukspolitiken 1985 – 2000.



Centrum för uthålligt lantbruk – CUL är ett samarbetsforum för forskare och andra med intresse för ekologiskt lantbruk och lantbrukets uthållighetsfrågor. CUL arbetar med utveckling av tvärvetenskapliga forskningsmetoder och för samverkan och samplanering av insatser för:

- forskning
  - utvecklingsarbete
  - utbildning
  - informations spridning
- inom det ekologiska lantbruket.



Centrum för uthålligt lantbruk  
Box 7047  
750 07 Uppsala  
[www.cul.slu.se](http://www.cul.slu.se)